

Single Student Housing Floor Plans

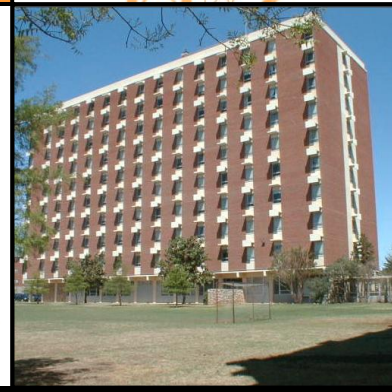

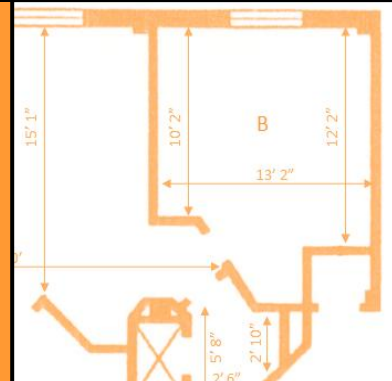

HOUSING AND Residential Life

Facilities Management

Directions:

- **To find a floor plan for a certain room:**
 - Select the building name on the Index Page
 - Then select a room number and you will be directed to the correct floor plan for that room

- **To find all rooms that are for a certain floor plan:**
 - Select the style of housing floor plan link on the right side of the Index Page
 - Rooms are sorted by building and then by room type
 - Select the floor plan link on the left to be directed to that floor plan
 - Use the Home key on your keyboard to be returned to the top of the document to search for a different room

- Press  +  to navigate back to the previous page that was being viewed

Floor Plan Index

Community Style

[Iba](#)

[Kerr - Drummond](#)

[Community Floor Plans by Room](#)

[Parker](#)

[Stout](#)

[Wentz](#)

Suite Style

[Bennett - Center](#)

[Bennett - East](#)

[Bennett Suite Floor Plans by Room](#)

[Bennett - West](#)

[Booker - Stinchcomb](#)

[Patchin - Jones](#)

[Other Suite Floor Plans by Room](#)

[Village C & D](#)

[Village CASNR](#)

[Village E & F](#)

[Village HES](#)

[Zink – Allen](#)

Apartment Style

[Bost](#)

[Davis](#)

[Apartment Floor Plans by Room](#)

[Kamm](#)

[Morsani - Smith](#)

[Peterson - Friend](#)

[Sitlington](#)

[Young](#)

Community Style



Iba

Room Number

*01

*16

*02

*17

*03

*18

*04

*19

*05

*20

*06

*21

*07

*22

*08

*23

*09

*24

*10

*25

*11

*26

*12

*27

*13

*28

*14

*29

*15

*30

*= Floor Number

Kerr - Drummond

Room Number

*01

*17

*02

*18

*03

*19

*04

*20

*05

*21

*06

*22

*07

*23

*08

*24

*09

*25

*10

*26

*11

*27

*12

*28

*13

*29

*14

*30

*15

*31

*16

*32

*= Floor Number

Parker

Room Number

<u>*01</u>	<u>*16</u>
<u>*02</u>	<u>*17</u>
<u>*03</u>	<u>*18</u>
<u>*04</u>	<u>*19</u>
<u>*05</u>	<u>*20</u>
<u>*06</u>	<u>*21</u>
<u>*07</u>	<u>*22</u>
<u>*08</u>	<u>*23</u>
<u>*09</u>	<u>*24</u>
<u>*10</u>	<u>*25</u>
<u>*11</u>	<u>*26</u>
<u>*12</u>	<u>*27</u>
<u>*13</u>	<u>*28</u>
<u>*14</u>	<u>*29</u>
<u>*15</u>	<u>*30</u>
*= Floor Number	

Wentz

Room Number

<u>*01</u>	<u>*17</u>
<u>*02</u>	<u>*18</u>
<u>*03</u>	<u>*19</u>
<u>*04</u>	<u>*20</u>
<u>*05</u>	<u>*21</u>
<u>*06</u>	<u>*22</u>
<u>*07</u>	<u>*23</u>
<u>*08</u>	<u>*24</u>
<u>*09</u>	<u>*25</u>
<u>*10</u>	<u>*26</u>
<u>*11</u>	<u>*27</u>
<u>*12</u>	<u>*28</u>
<u>*13</u>	<u>*29</u>
<u>*14</u>	<u>*30</u>
<u>*15</u>	<u>*31</u>
<u>*16</u>	<u>*32</u>
*= Floor Number	

Community Floor Plan 1

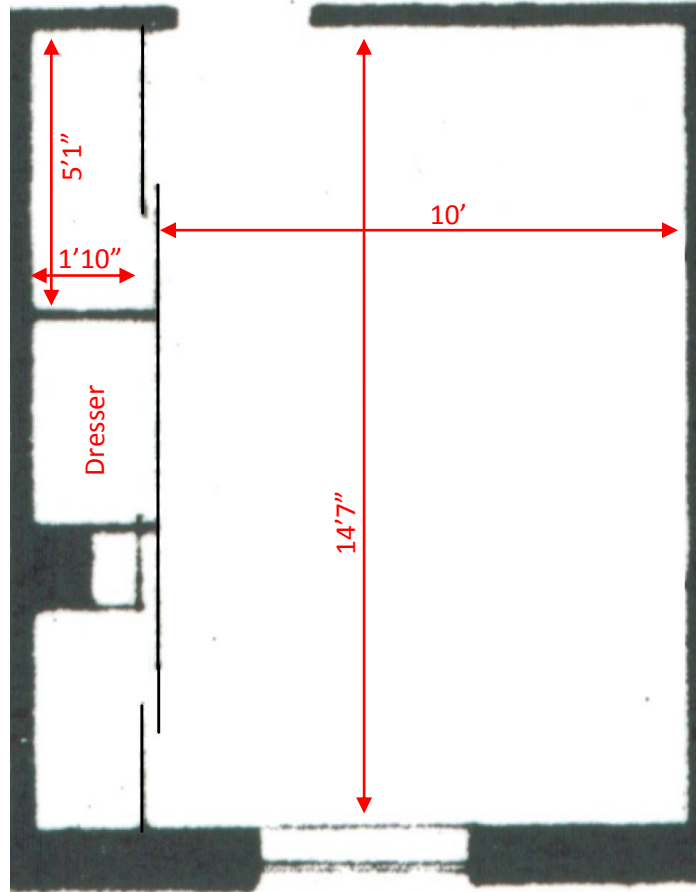

46" x 58"
Window

*Room floor plans may be mirror image depending on location.

*All Dimensions are approximate and may vary from room to room.

Community Floor Plan 2 (End Room)

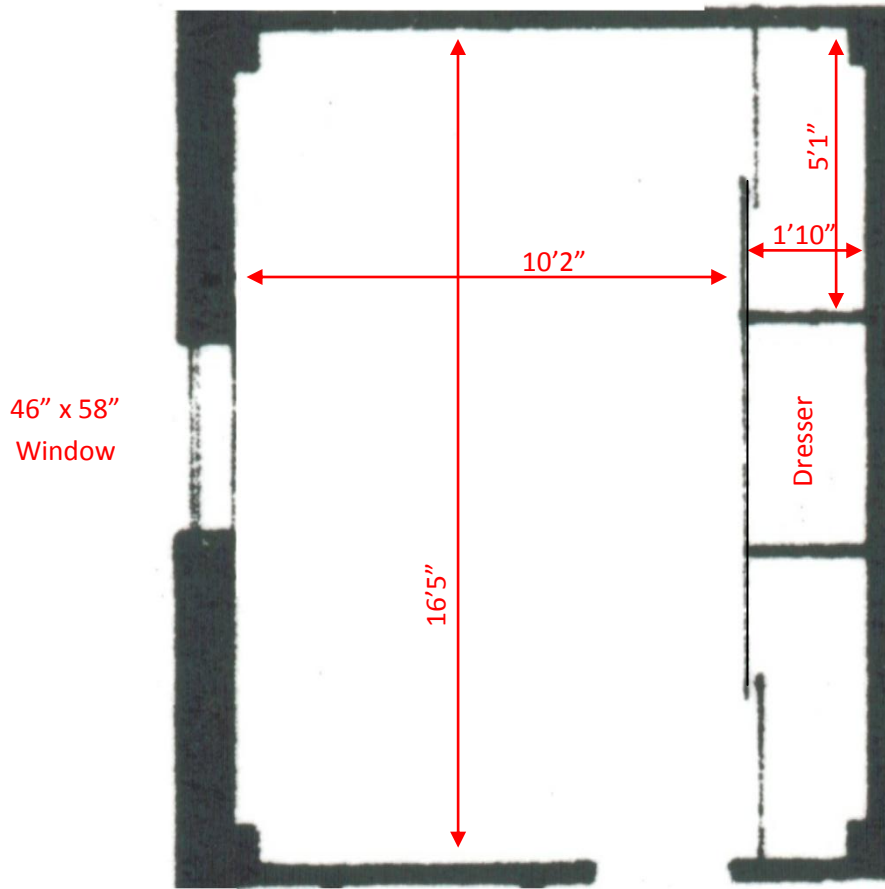

*Room floor plans may be mirror image depending on location.

*All Dimensions are approximate and may vary from room to room.

Community Floor Plan 3 (Corner End Room)

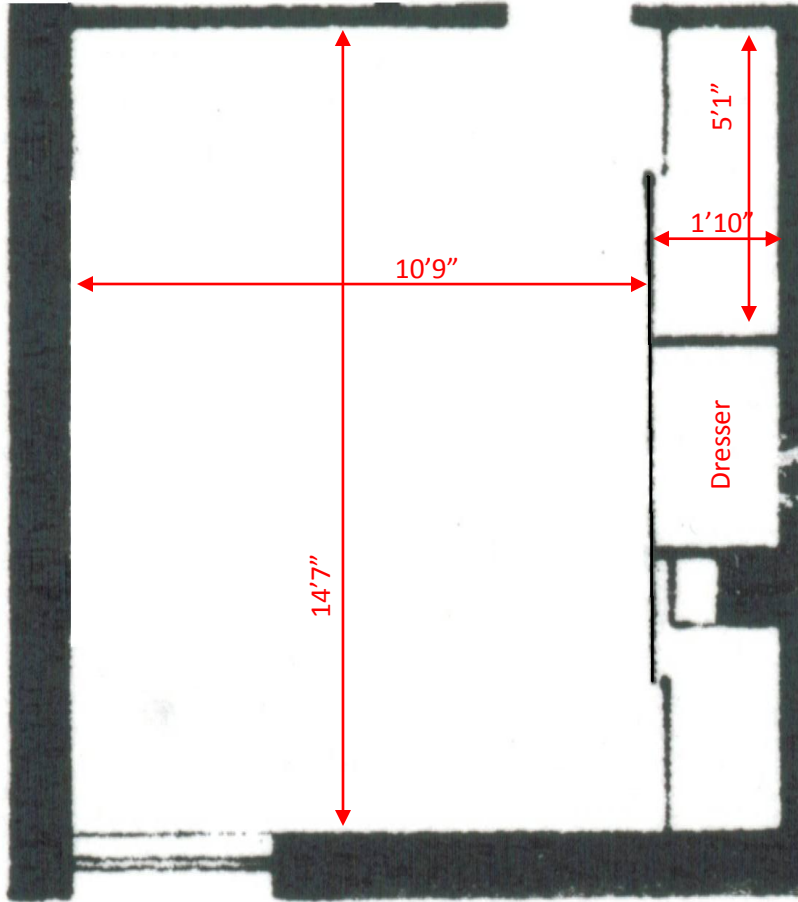

46" x 58"
Window

*Room floor plans may be mirror image depending on location.

*All Dimensions are approximate and may vary from room to room.

Community Floor Plan 4 (Room With Bathroom)

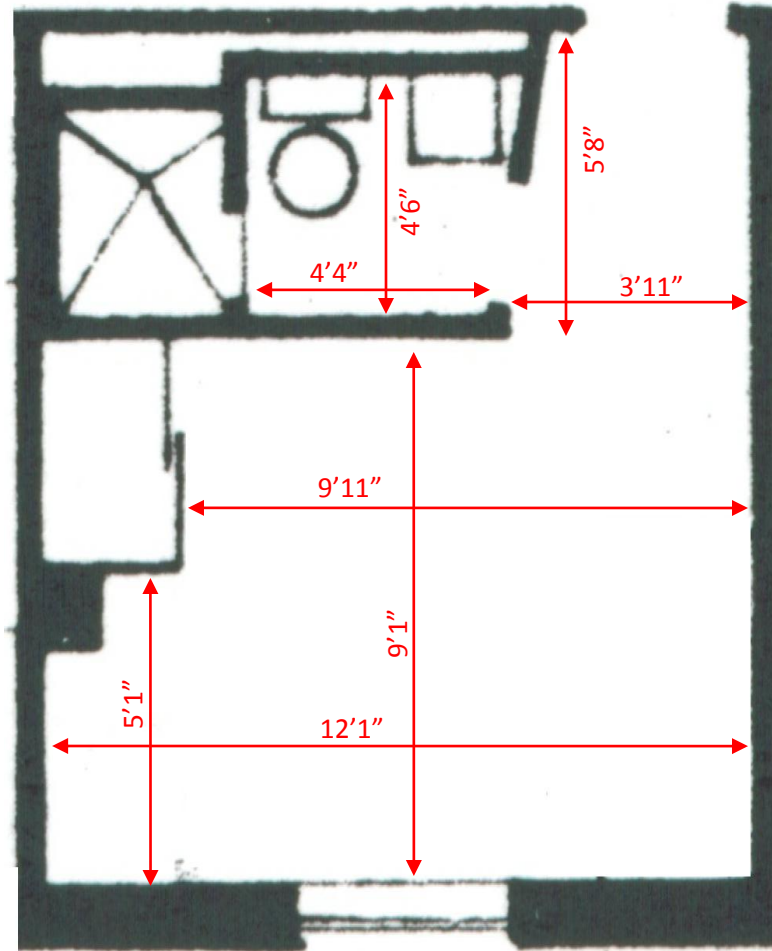

46" x 58"
Window

*Room floor plans may be mirror image depending on location.

*All Dimensions are approximate and may vary from room to room.

Stout

Room Number

<u>103</u>	<u>201</u>	<u>249</u>	<u>318</u>	<u>374</u>	<u>461</u>
<u>104</u>	<u>203</u>	<u>250</u>	<u>319</u>	<u>375</u>	<u>462</u>
<u>105</u>	<u>204</u>	<u>251</u>	<u>320</u>	<u>376</u>	<u>463</u>
<u>106</u>	<u>205</u>	<u>252</u>	<u>331</u>	<u>377</u>	<u>464</u>
<u>107</u>	<u>207</u>	<u>261</u>	<u>332</u>	<u>378</u>	<u>465</u>
<u>108</u>	<u>208</u>	<u>263</u>	<u>333</u>	<u>379</u>	<u>467</u>
<u>109</u>	<u>209</u>	<u>264</u>	<u>334</u>	<u>380</u>	<u>469</u>
<u>111</u>	<u>211</u>	<u>265</u>	<u>335</u>	<u>403</u>	<u>471</u>
<u>112</u>	<u>212</u>	<u>267</u>	<u>336</u>	<u>404</u>	<u>472</u>
<u>113</u>	<u>213</u>	<u>268</u>	<u>337</u>	<u>405</u>	<u>473</u>
<u>114</u>	<u>214</u>	<u>269</u>	<u>338</u>	<u>407</u>	<u>474</u>
<u>115</u>	<u>215</u>	<u>271</u>	<u>339</u>	<u>409</u>	<u>476</u>
<u>116</u>	<u>216</u>	<u>272</u>	<u>340</u>	<u>411</u>	<u>478</u>
<u>117</u>	<u>217</u>	<u>273</u>	<u>341</u>	<u>412</u>	<u>480</u>
<u>118</u>	<u>218</u>	<u>274</u>	<u>342</u>	<u>413</u>	
<u>119</u>	<u>219</u>	<u>275</u>	<u>343</u>	<u>414</u>	
<u>120</u>	<u>220</u>	<u>276</u>	<u>344</u>	<u>416</u>	
<u>161</u>	<u>231</u>	<u>277</u>	<u>345</u>	<u>418</u>	
<u>163</u>	<u>232</u>	<u>278</u>	<u>346</u>	<u>420</u>	
<u>164</u>	<u>233</u>	<u>279</u>	<u>347</u>	<u>431</u>	
<u>165</u>	<u>234</u>	<u>280</u>	<u>348</u>	<u>432</u>	
<u>167</u>	<u>235</u>	<u>301</u>	<u>349</u>	<u>435</u>	
<u>168</u>	<u>236</u>	<u>303</u>	<u>350</u>	<u>436</u>	
<u>169</u>	<u>237</u>	<u>304</u>	<u>351</u>	<u>437</u>	
<u>170</u>	<u>238</u>	<u>305</u>	<u>352</u>	<u>438</u>	
<u>171</u>	<u>239</u>	<u>307</u>	<u>361</u>	<u>439</u>	
<u>172</u>	<u>240</u>	<u>308</u>	<u>363</u>	<u>440</u>	
<u>173</u>	<u>241</u>	<u>309</u>	<u>364</u>	<u>443</u>	
<u>174</u>	<u>242</u>	<u>311</u>	<u>365</u>	<u>444</u>	
<u>175</u>	<u>243</u>	<u>312</u>	<u>367</u>	<u>445</u>	
<u>176</u>	<u>244</u>	<u>313</u>	<u>368</u>	<u>446</u>	
<u>177</u>	<u>245</u>	<u>314</u>	<u>369</u>	<u>449</u>	
<u>178</u>	<u>246</u>	<u>315</u>	<u>371</u>	<u>450</u>	
<u>179</u>	<u>247</u>	<u>316</u>	<u>372</u>	<u>451</u>	
<u>180</u>	<u>248</u>	<u>317</u>	<u>373</u>	<u>452</u>	

Stout Floor Plan 1 (Standard Room)

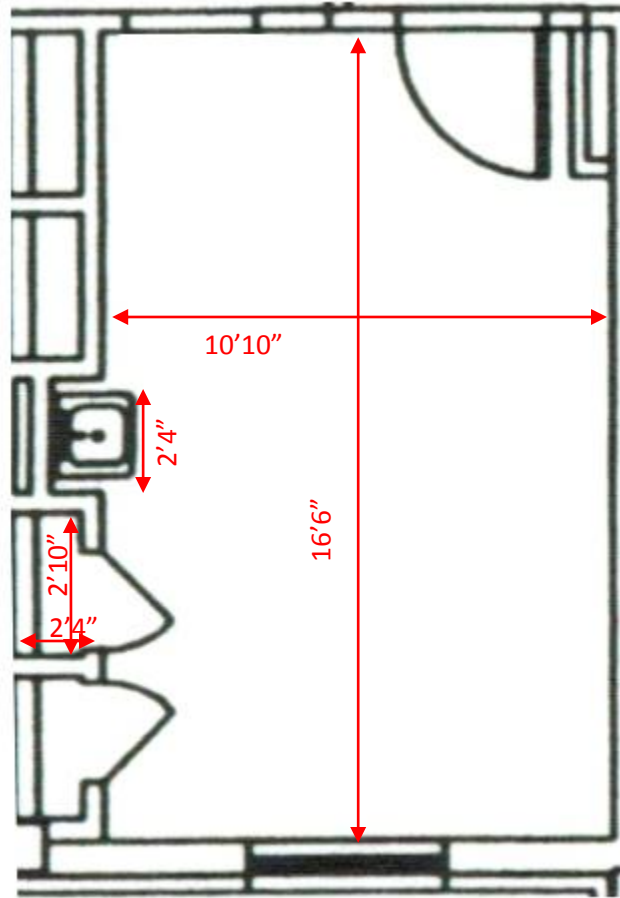

*Room floor plans may be mirror image depending on location.

*All Dimensions are approximate and may vary from room to room.

1st Floor - 74"x40" Window
2nd and 3rd Floor - 63"x40" Window

Stout Floor Plan 2

1st Floor - 74"x40" Window
2nd and 3rd Floor - 63"x40" Window

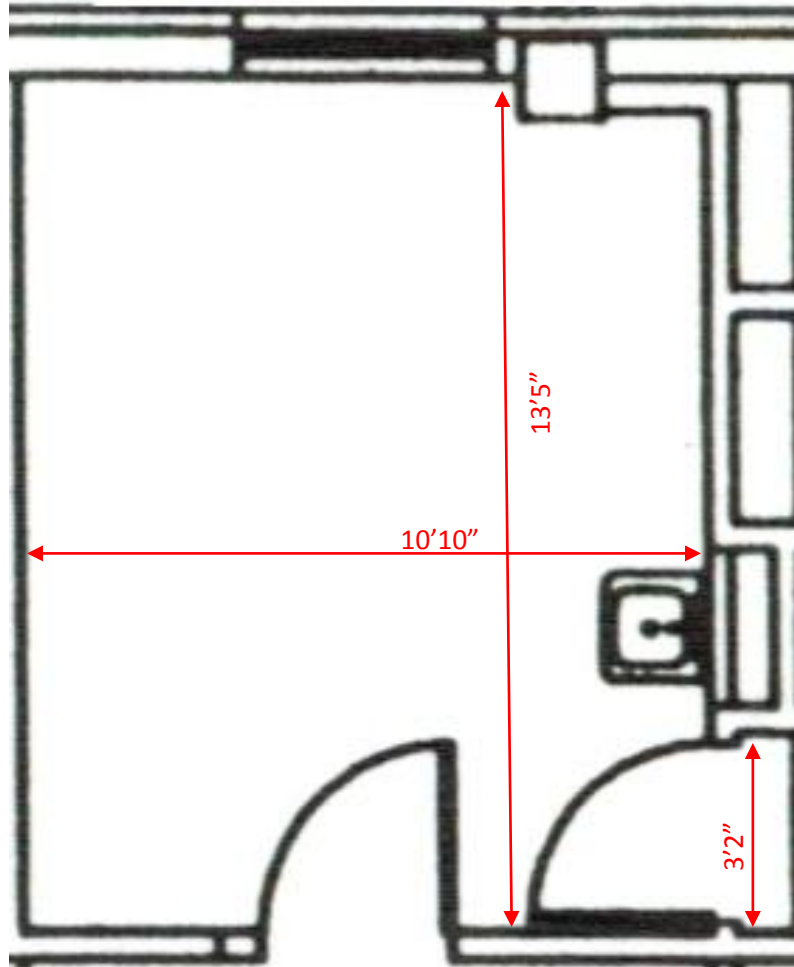

*Room floor plans may be mirror image depending on location.

*All Dimensions are approximate and may vary from room to room.

Stout Floor Plan 3

1st Floor - 74"x40" Windows
2nd and 3rd Floor – 63"x40" Windows

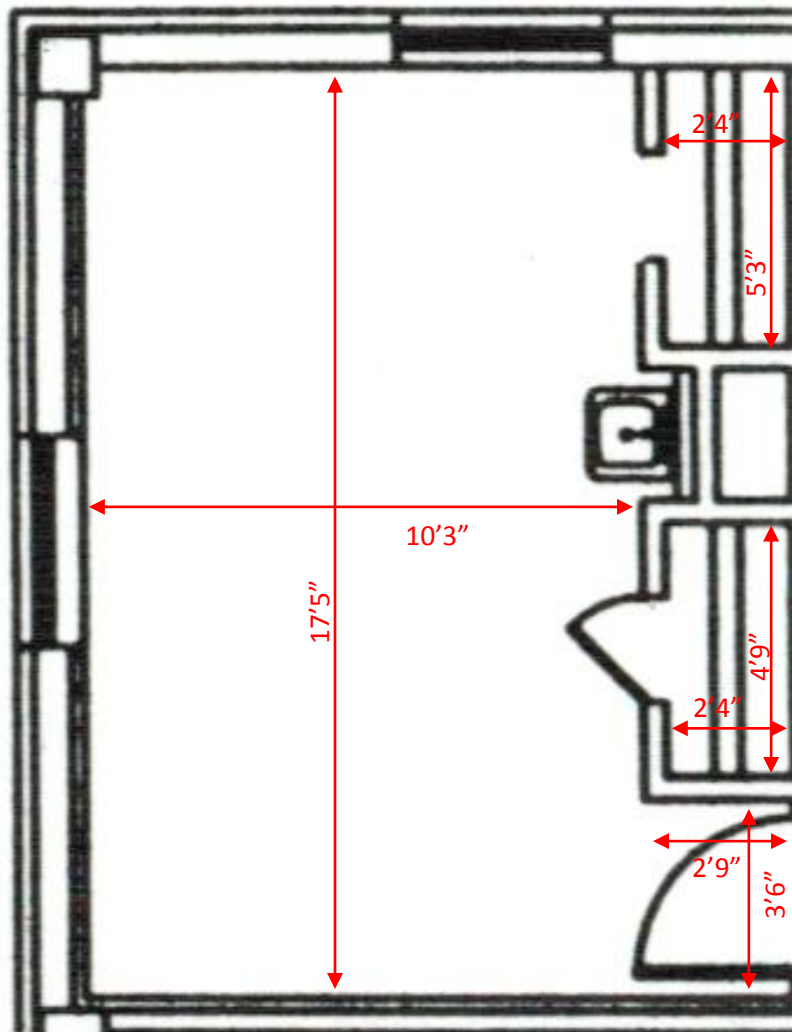

*Room floor plans may be mirror image depending on location.

*All Dimensions are approximate and may vary from room to room.

Stout Floor Plan 4

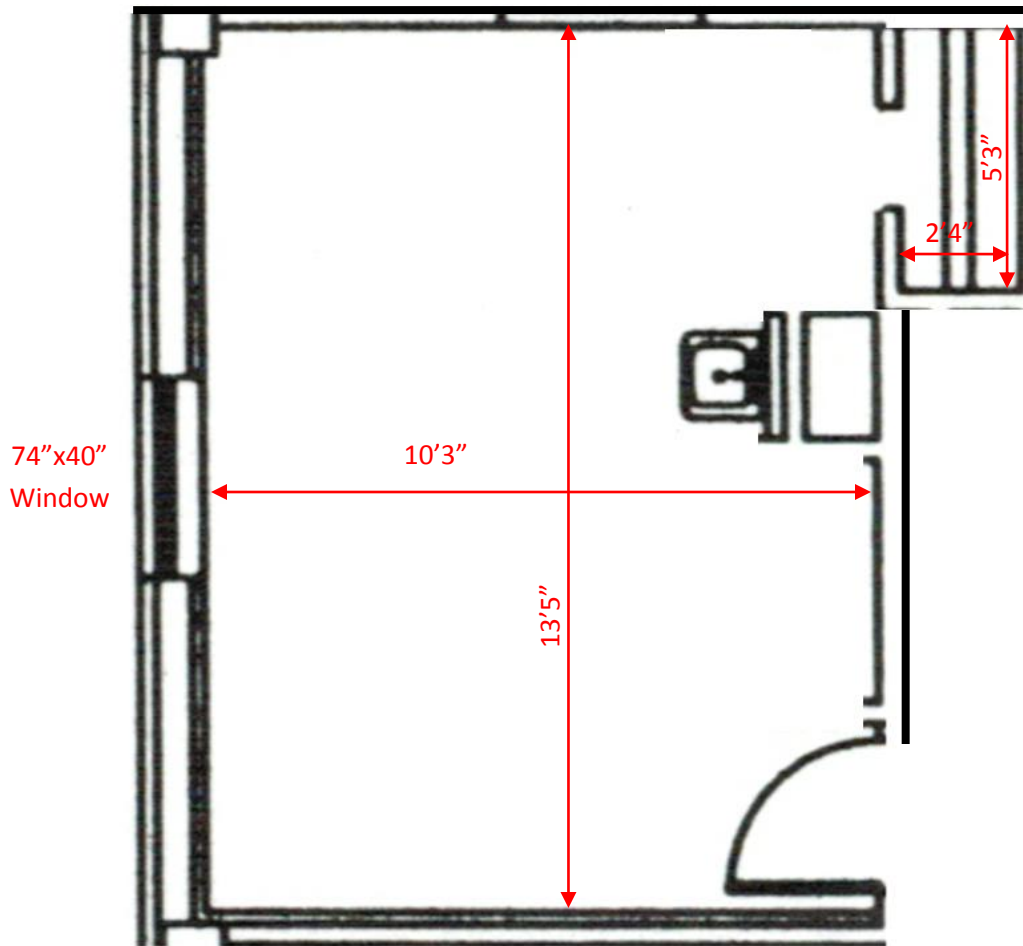

*Room floor plans may be mirror image depending on location.

*All Dimensions are approximate and may vary from room to room.

Stout Floor Plan 5

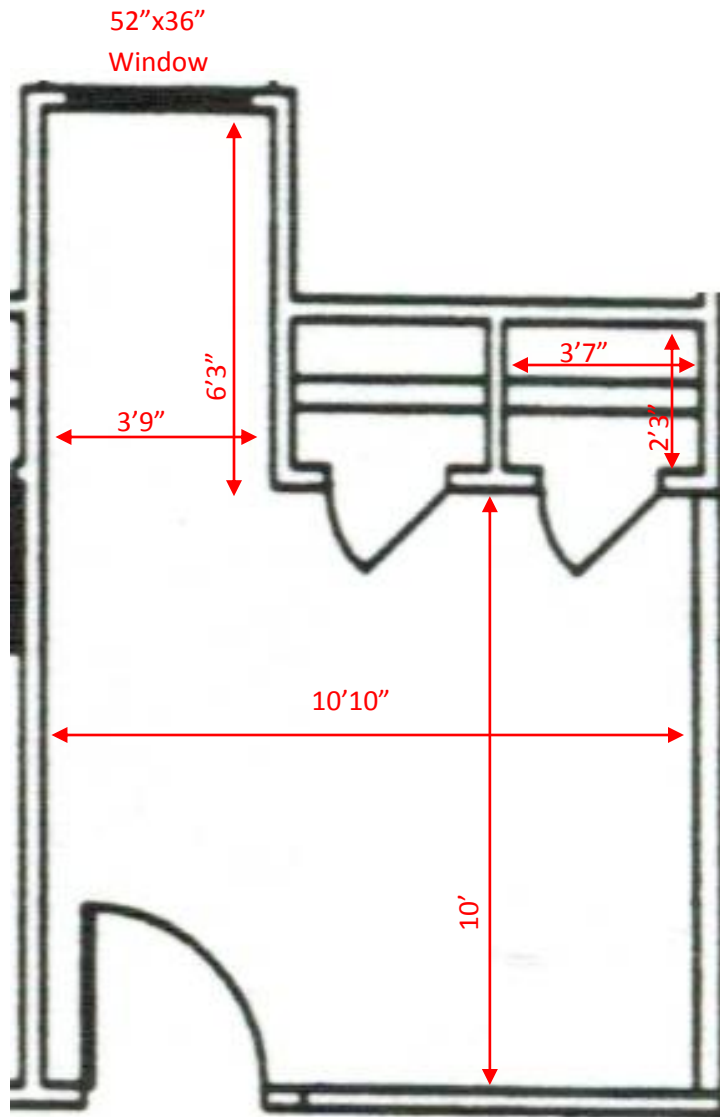

*Room floor plans may be mirror image depending on location.

*All Dimensions are approximate and may vary from room to room.

Stout Floor Plan 6

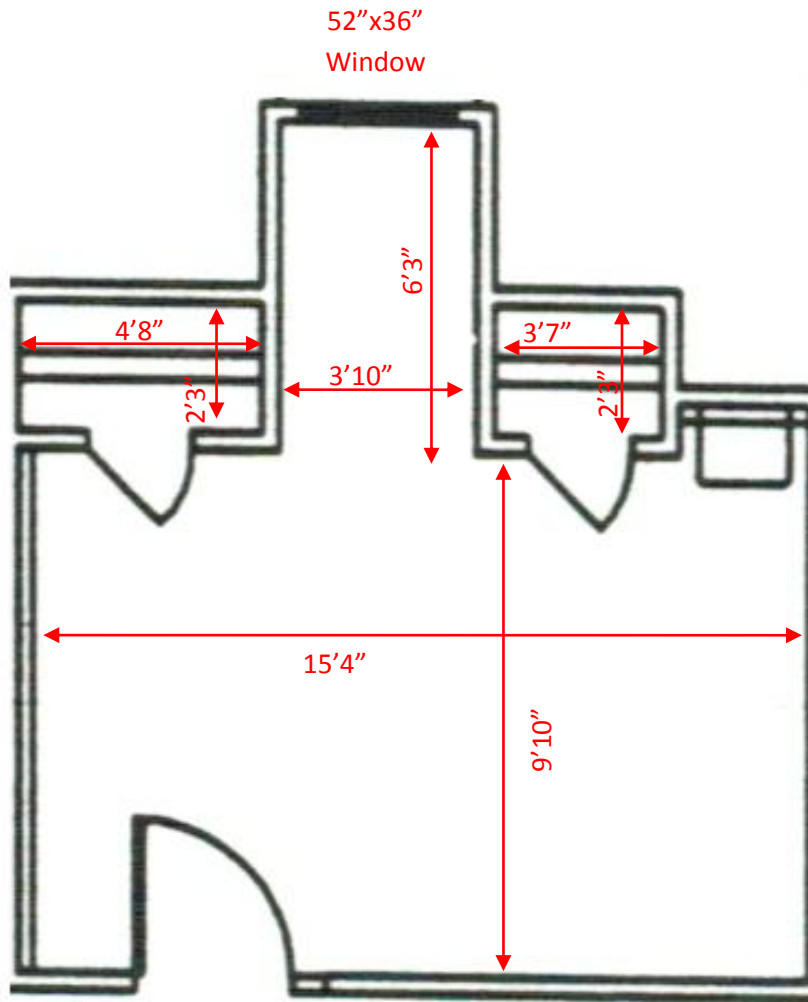

*Room floor plans may be mirror image depending on location.

*All Dimensions are approximate and may vary from room to room.

Stout Floor Plan 7

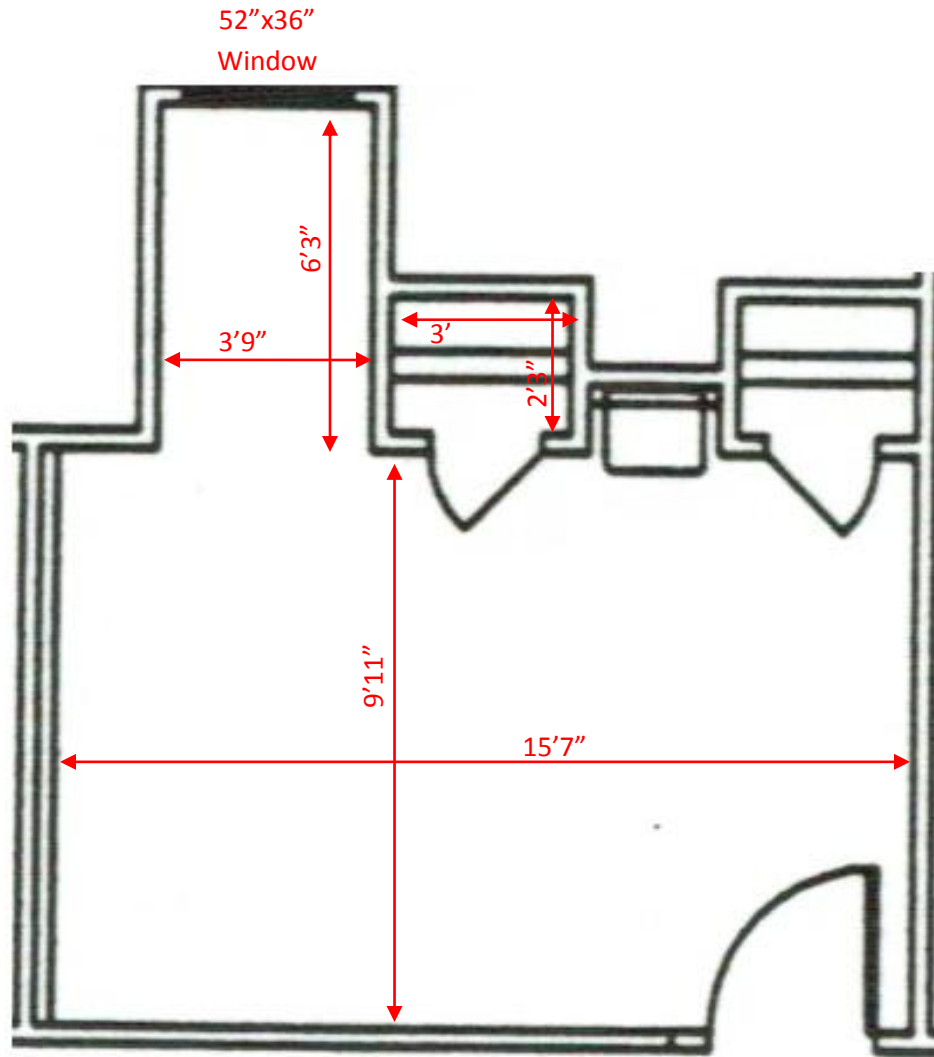

*Room floor plans may be mirror image depending on location.

*All Dimensions are approximate and may vary from room to room.

Stout Floor Plan 8

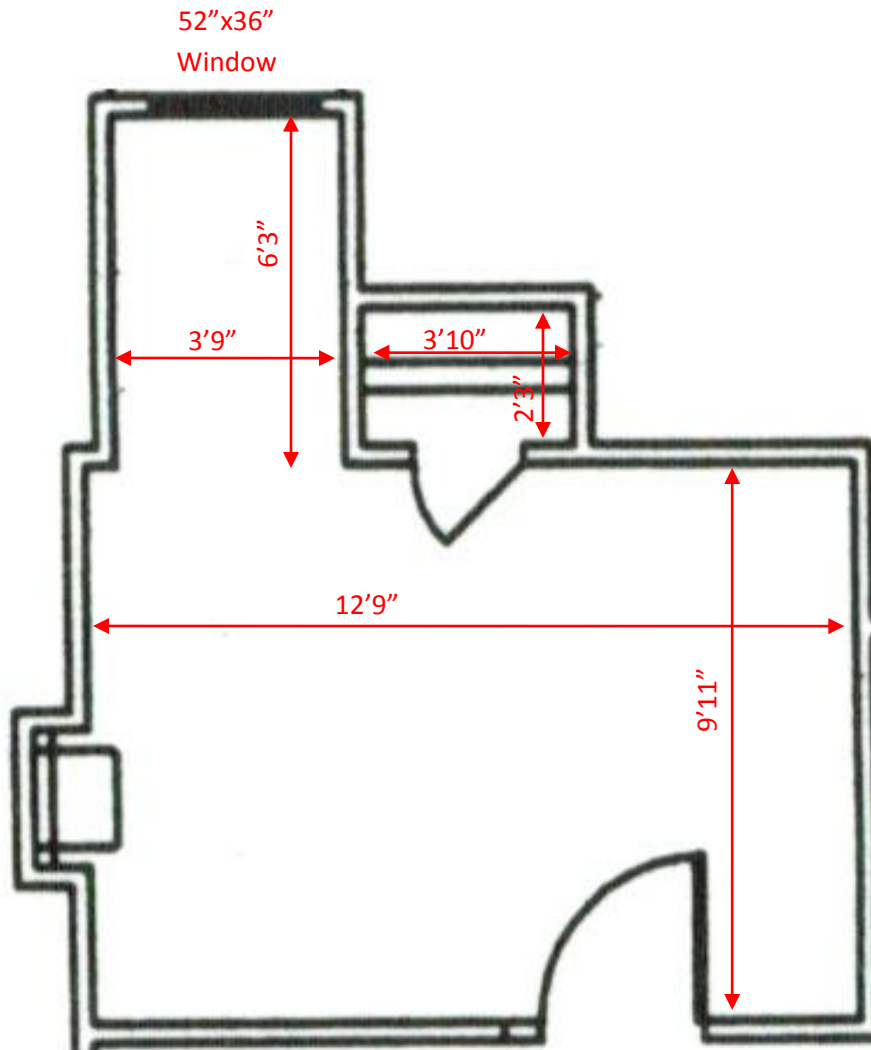

*Room floor plans may be mirror image depending on location.

*All Dimensions are approximate and may vary from room to room.

Stout Floor Plan 9

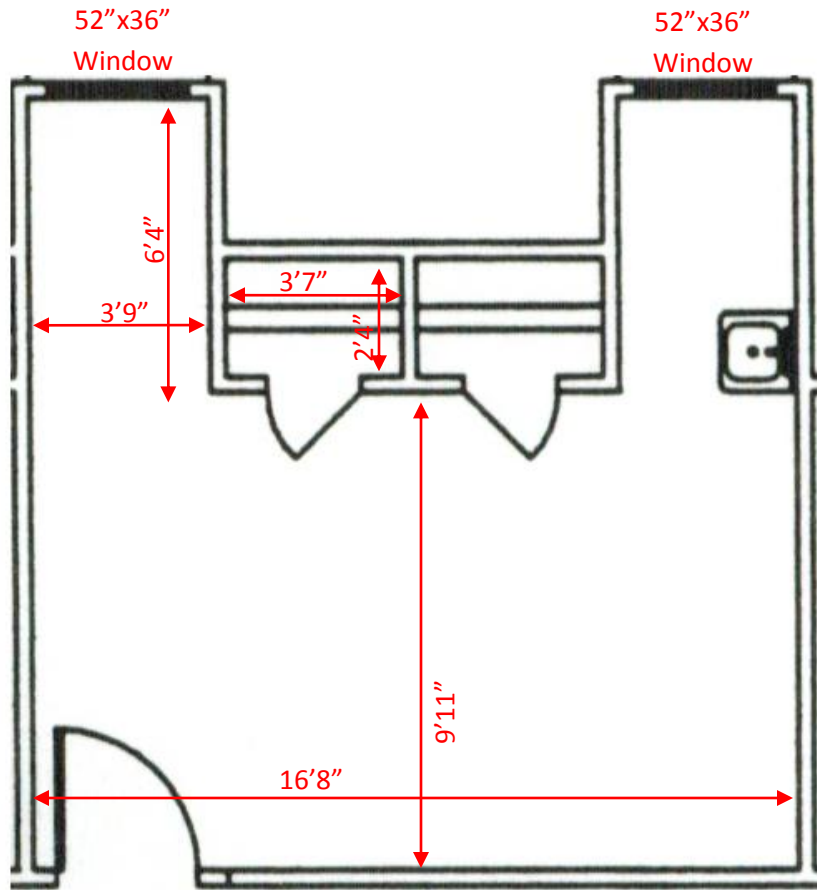

*Room floor plans may be mirror image depending on location.

*All Dimensions are approximate and may vary from room to room.

Stout Floor Plan 10

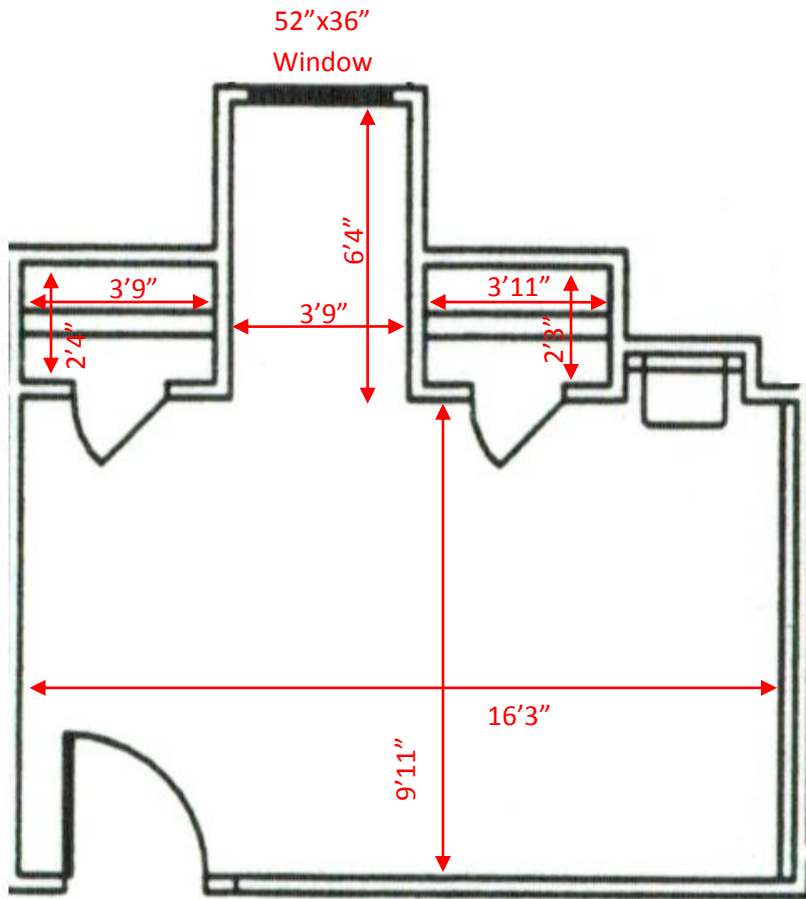

*Room floor plans may be mirror image depending on location.

*All Dimensions are approximate and may vary from room to room.

Stout Floor Plan 11

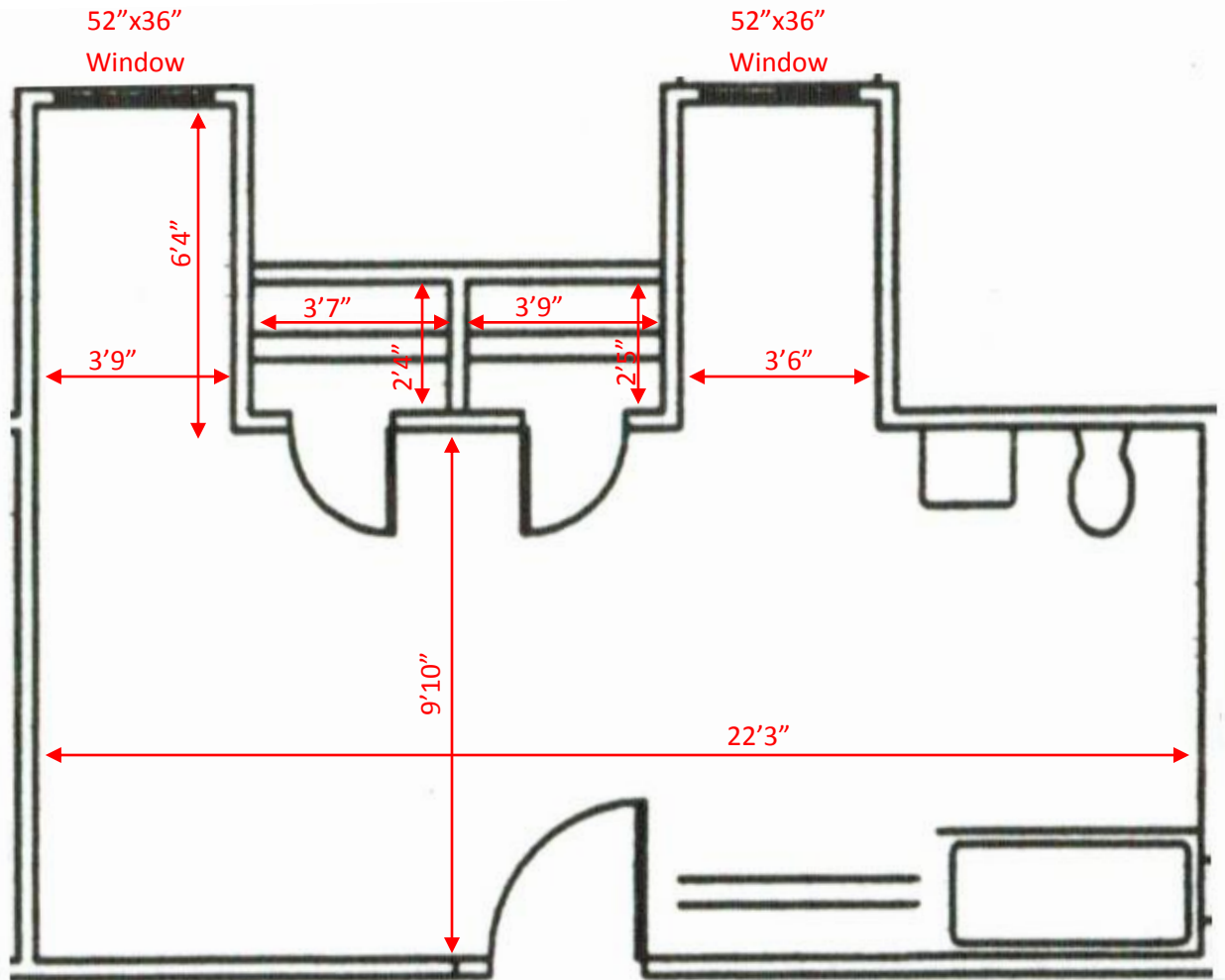

*Room floor plans may be mirror image depending on location.

*All Dimensions are approximate and may vary from room to room.

Stout Floor Plan 12

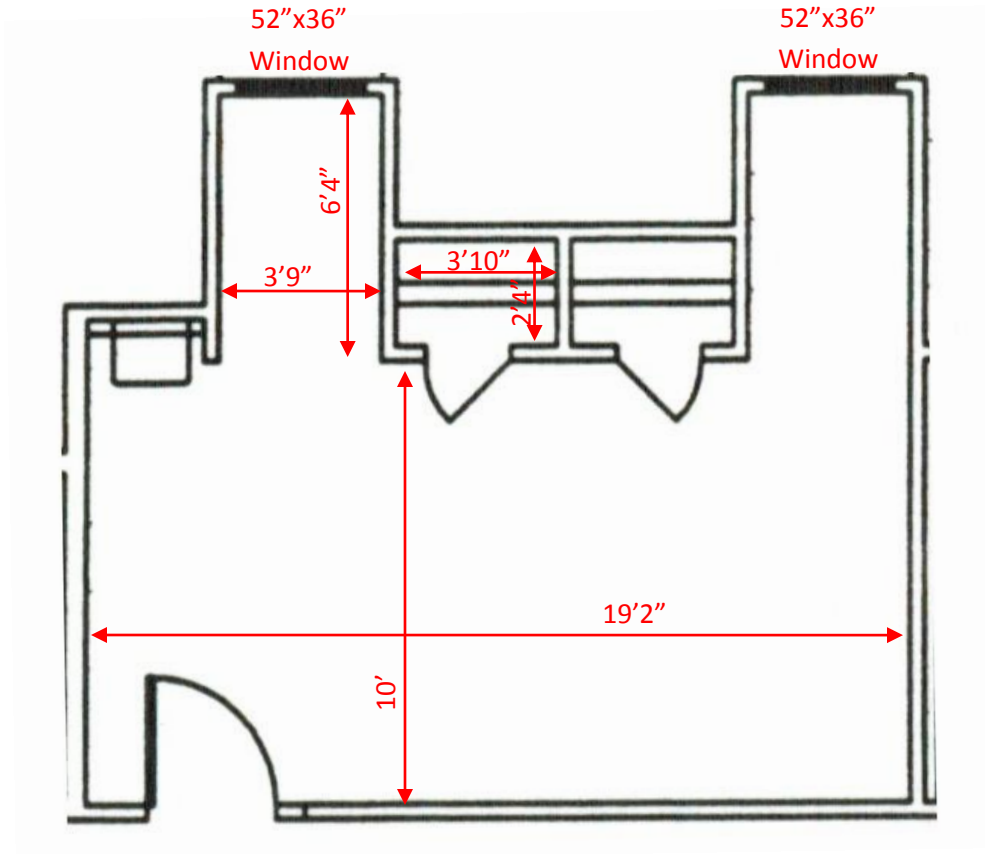

*Room floor plans may be mirror image depending on location.

*All Dimensions are approximate and may vary from room to room.

Stout Floor Plan 13

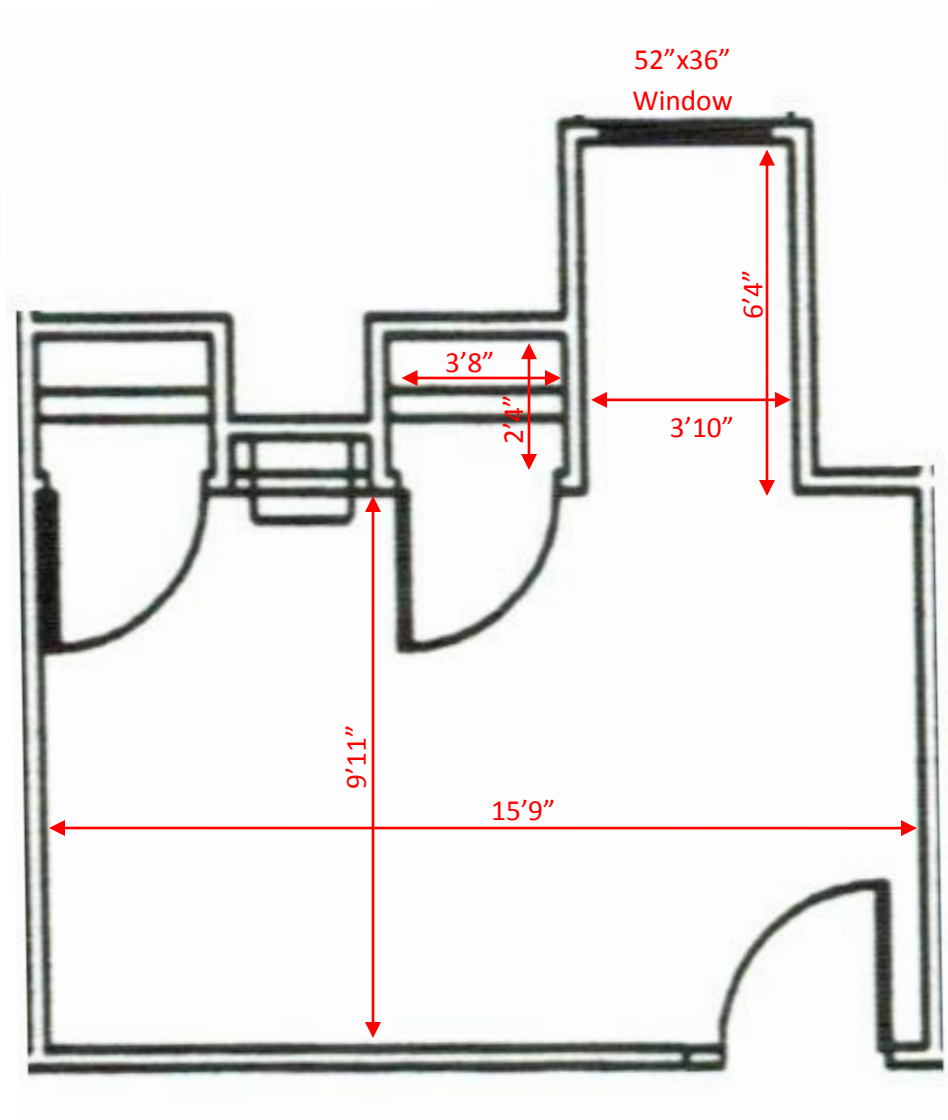

*Room floor plans may be mirror image depending on location.

*All Dimensions are approximate and may vary from room to room.

Stout Floor Plan 14

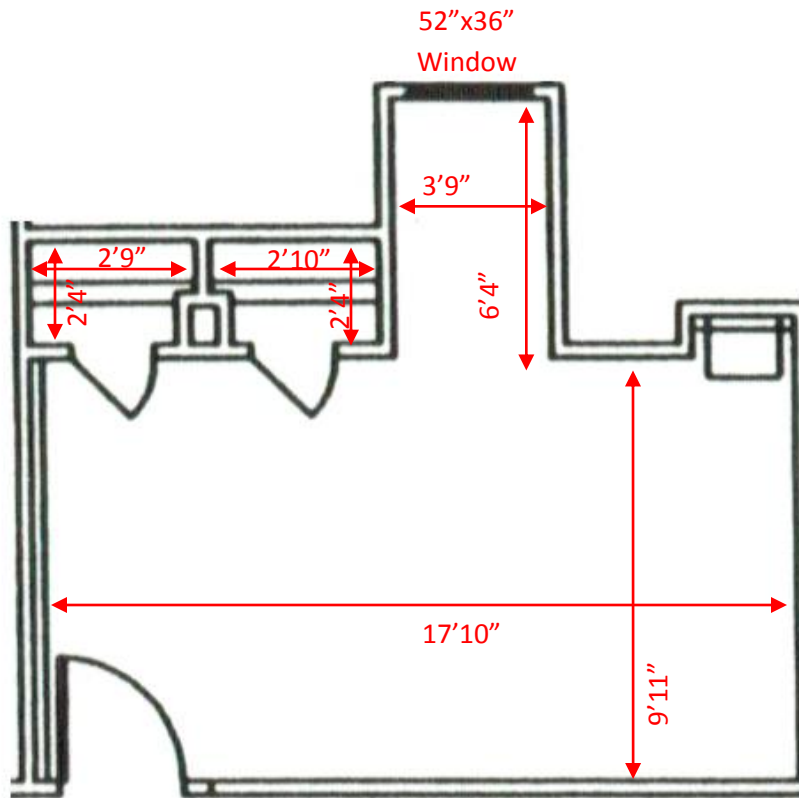

*Room floor plans may be mirror image depending on location.

*All Dimensions are approximate and may vary from room to room.

Stout Floor Plan 15

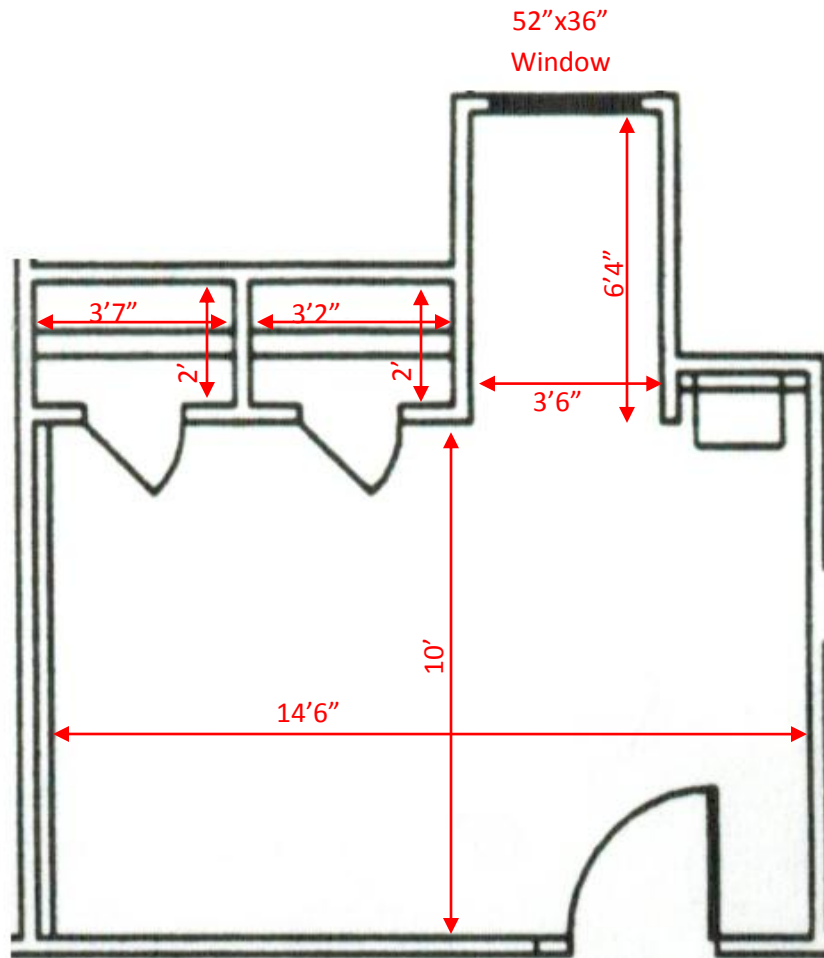

*Room floor plans may be mirror image depending on location.

*All Dimensions are approximate and may vary from room to room.

Stout Floor Plan 16

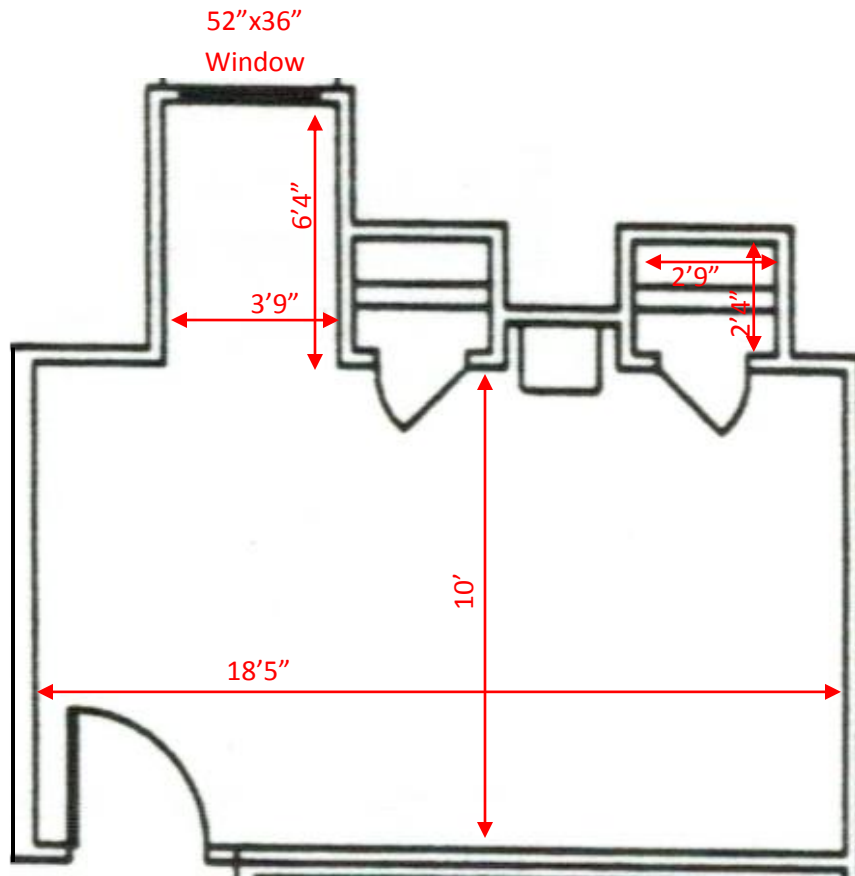

*Room floor plans may be mirror image depending on location.

*All Dimensions are approximate and may vary from room to room.

Stout Floor Plan 17

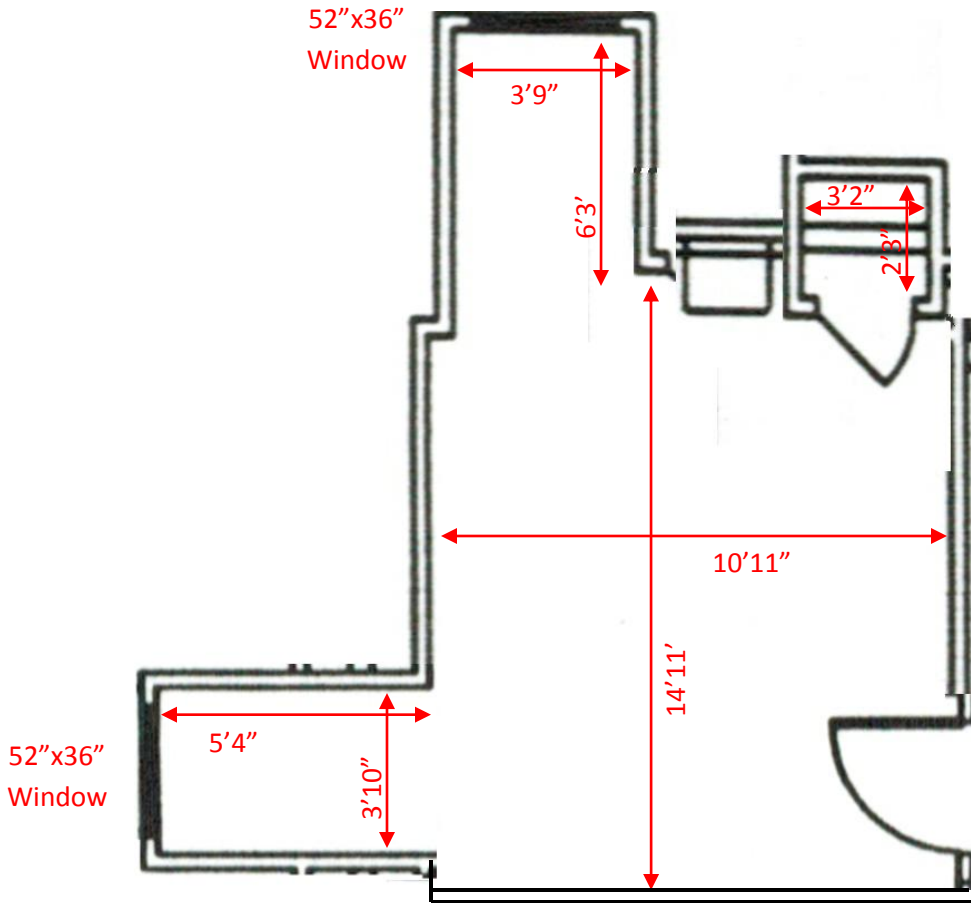

*Room floor plans may be mirror image depending on location.

*All Dimensions are approximate and may vary from room to room.

Stout Floor Plan 18

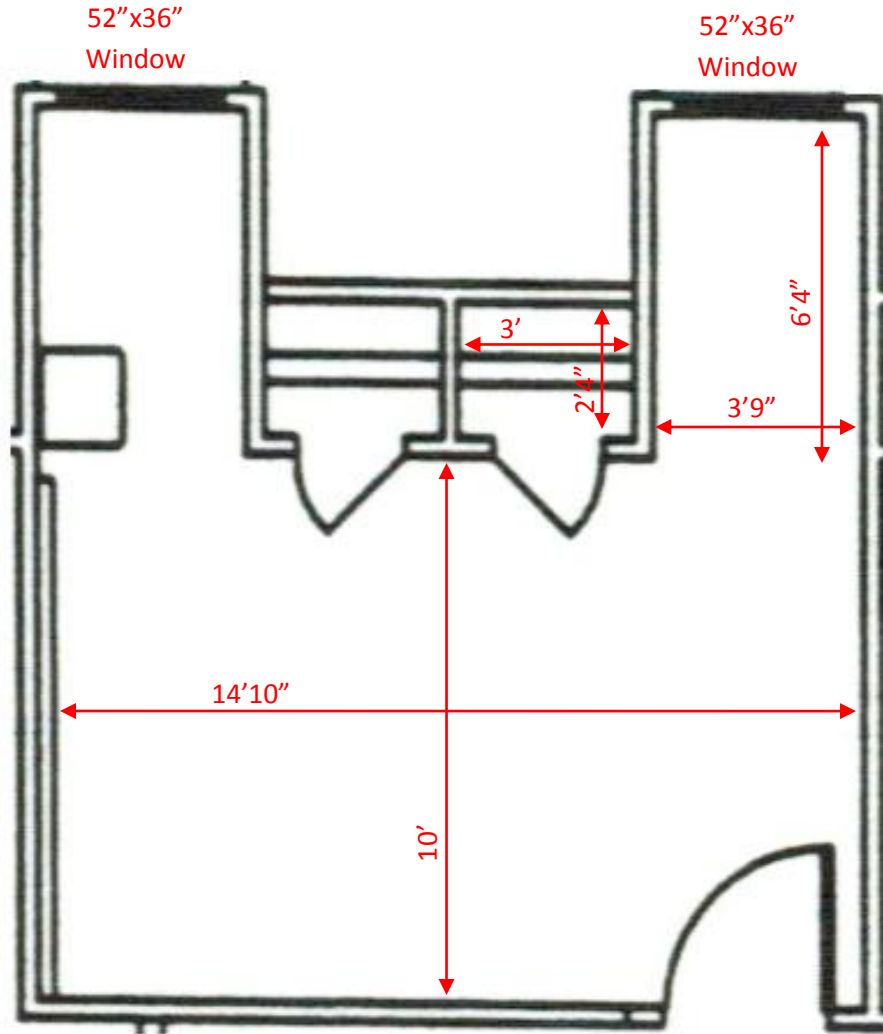

*Room floor plans may be mirror image depending on location.

*All Dimensions are approximate and may vary from room to room.

Stout Floor Plan 19

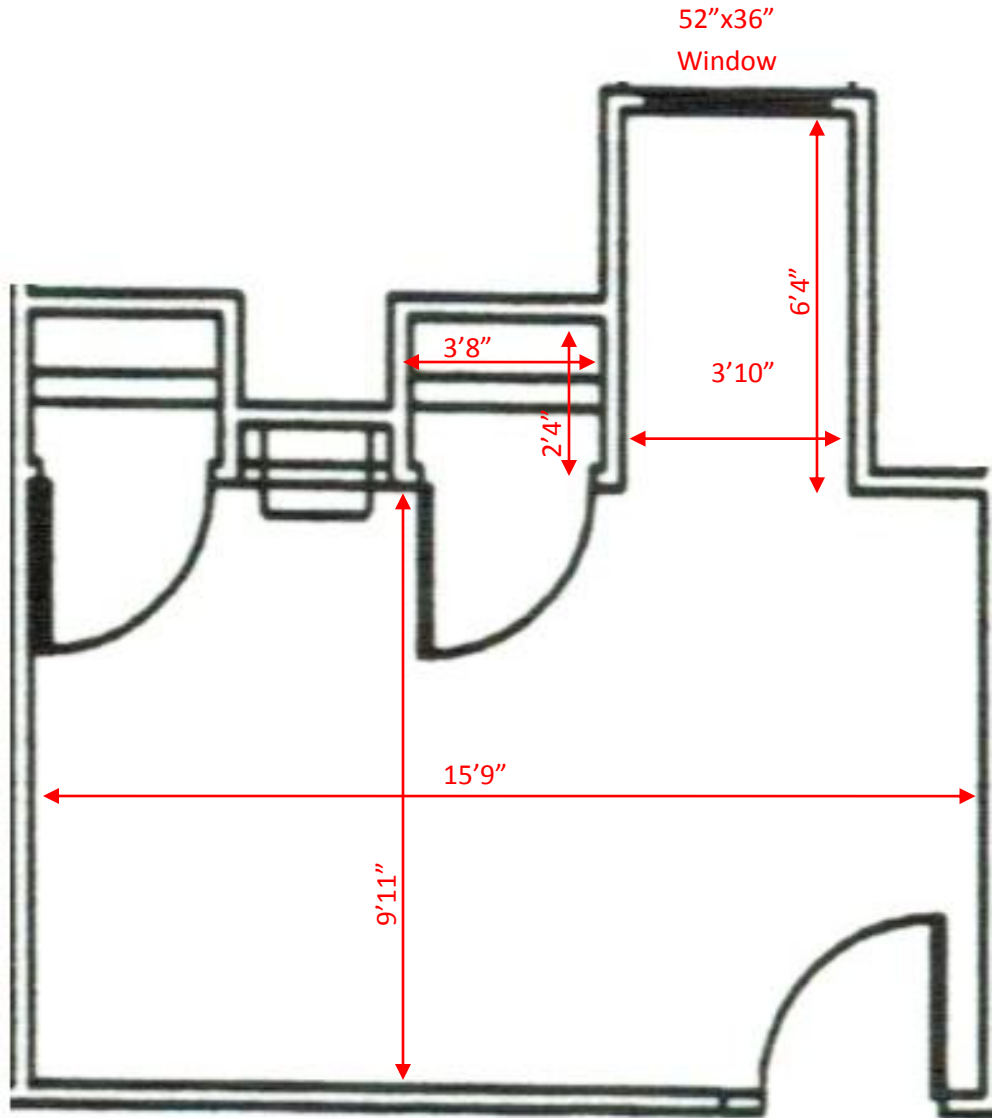

*Room floor plans may be mirror image depending on location.

*All Dimensions are approximate and may vary from room to room.

Stout Floor Plan 20

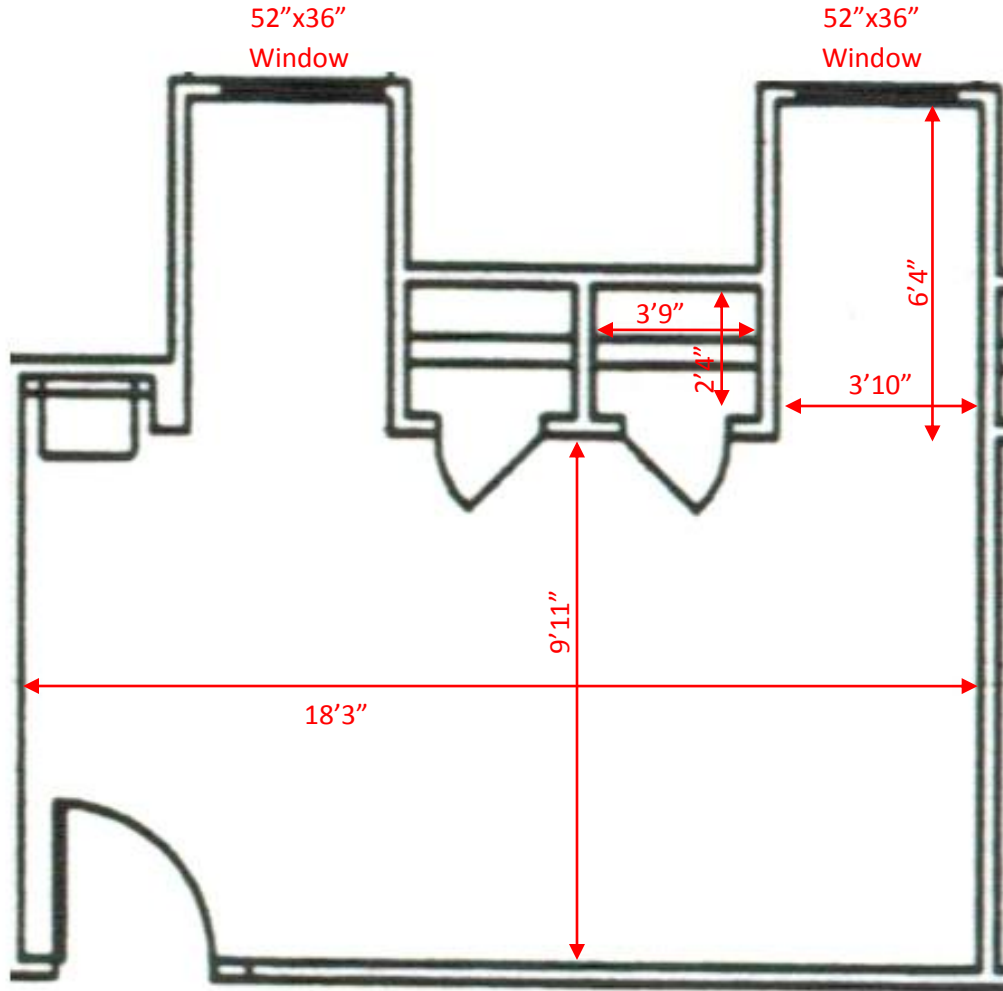

*Room floor plans may be mirror image depending on location.

*All Dimensions are approximate and may vary from room to room.

Stout Floor Plan 21

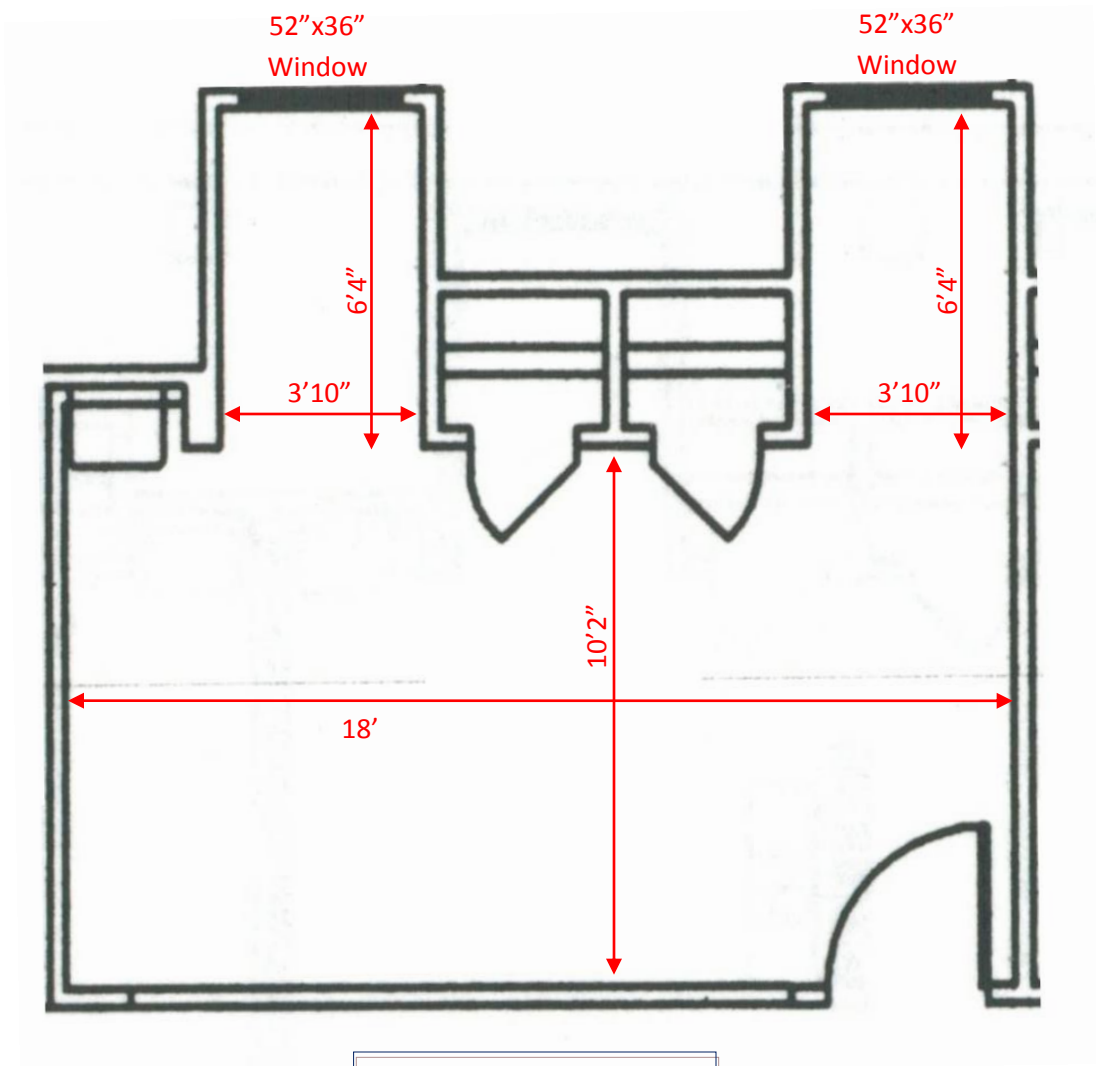

*Room floor plans may be mirror image depending on location.

*All Dimensions are approximate and may vary from room to room.

Stout Floor Plan 22

2nd and 3rd Floor – 63"x40" Window

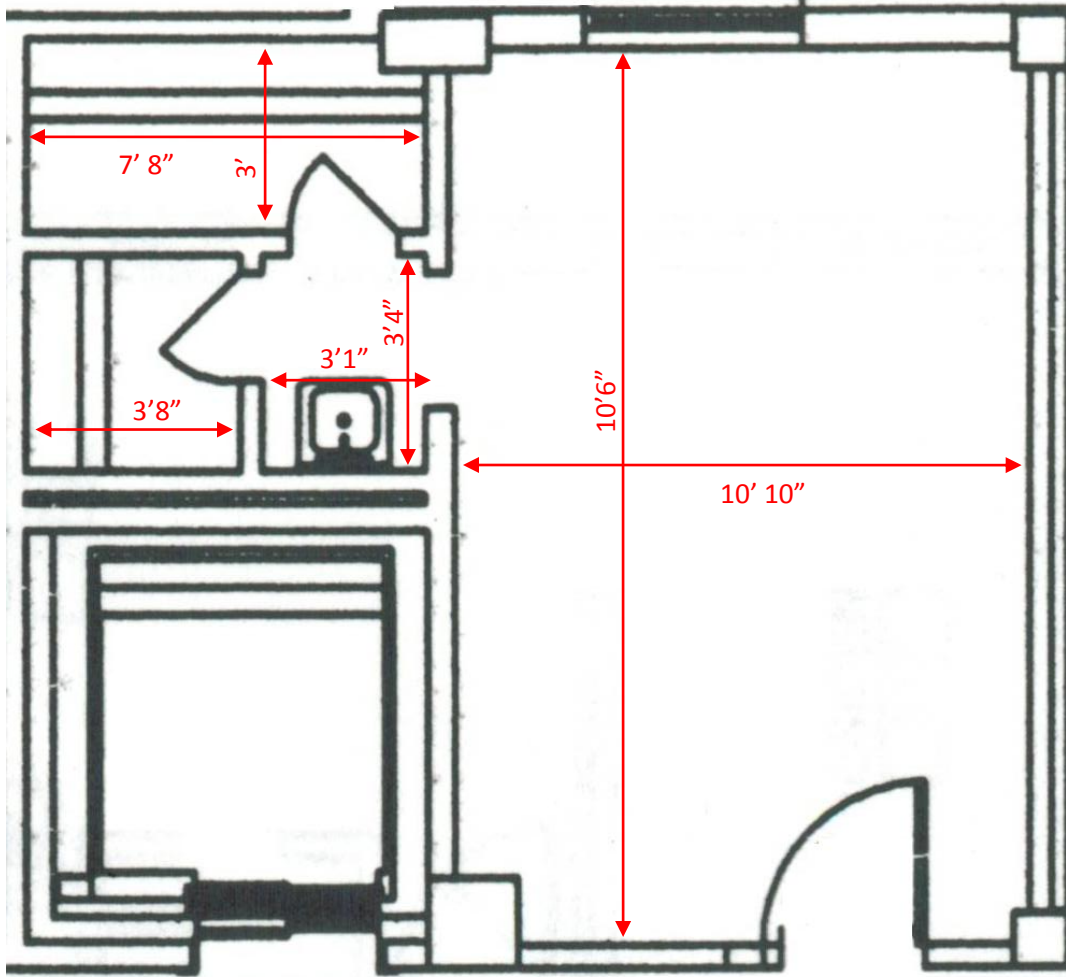

*Room floor plans may be mirror image depending on location.

*All Dimensions are approximate and may vary from room to room.

Stout Floor Plan 23

2nd and 3rd Floor – 63"x40" Window

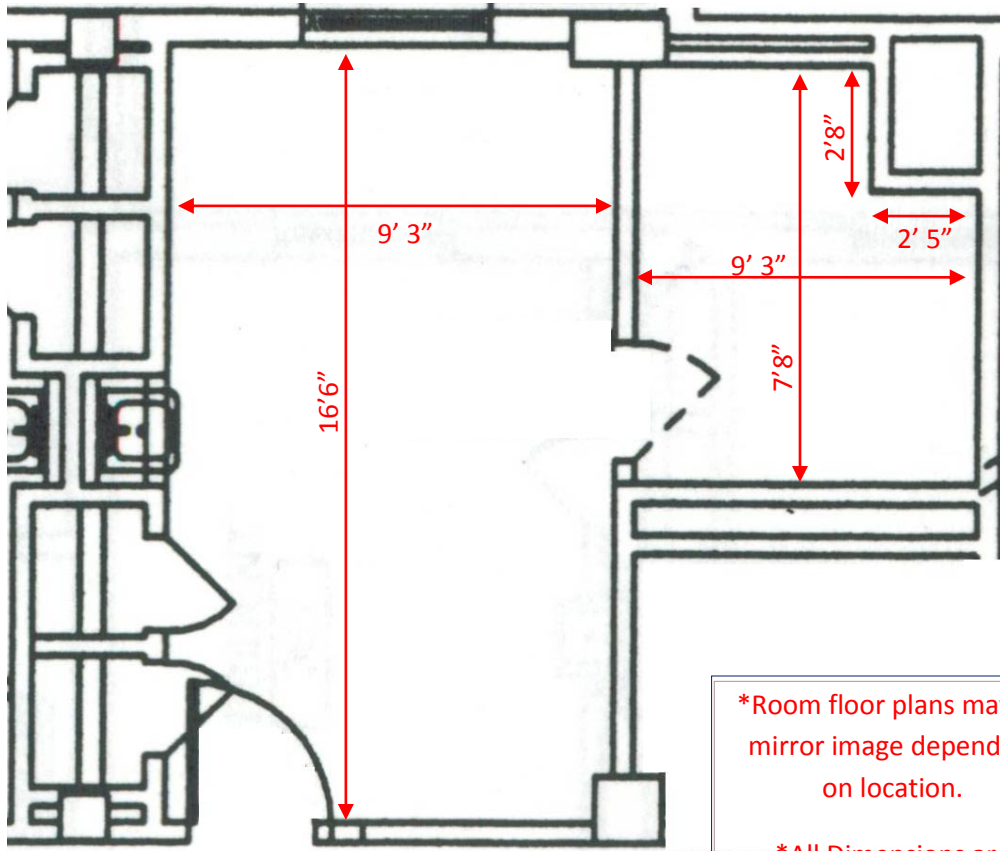

*Room floor plans may be mirror image depending on location.

*All Dimensions are approximate and may vary from room to room.

Floor Plan Type	Room Number		
Stout			

<u>Stout Floor Plan 1</u>	103	201	301
	104	203	303
	105	204	304
	106	205	305
	107	207	307
	108	208	308
	109	209	309
	111	211	311
	112	212	312
	113	213	313
	114	214	314
	115	215	315
	116	216	316
	117	217	317
	161	231	331
	163	233	333
	164	234	334
	165	235	335
	167	236	336
	168	237	337
	169	238	338
	170	239	339
	171	240	340
	172	241	341
	173	242	342
	174	243	343
	175	244	344
	176	245	345
	177	246	346
		247	347
		248	348
		249	349
		250	350
		251	351
		261	361
		263	363
		264	364
		265	365
		267	367
		268	368

		269	369
		271	371
		272	372
		273	373
		274	374
		275	375
		276	376
		277	377

<u>Stout Floor Plan 2</u>	119	219	319
	179	279	379

<u>Stout Floor Plan 3</u>	118	218	318
	120	220	320
	178	278	378
		280	380

<u>Stout Floor Plan 4</u>	180		
---------------------------	-----	--	--

<u>Stout Floor Plan 5</u>	403		
---------------------------	-----	--	--

<u>Stout Floor Plan 6</u>	405	412	471
	411	465	472

<u>Stout Floor Plan 7</u>	409	469	
	416	476	

<u>Stout Floor Plan 8</u>	418	478	
	420	480	

<u>Stout Floor Plan 9</u>	439	449	
	440	450	

<u>Stout Floor Plan 10</u>	435	438	445
	436	443	446
	437	444	

<u>Stout Floor Plan 11</u>	431		
----------------------------	-----	--	--

<u>Stout Floor Plan 12</u>	432		
----------------------------	-----	--	--

<u>Stout Floor Plan 13</u>	404		
----------------------------	-----	--	--

<u>Stout Floor Plan 14</u>	451	
<u>Stout Floor Plan 15</u>	452	
<u>Stout Floor Plan 16</u>	461	
<u>Stout Floor Plan 17</u>	462	
<u>Stout Floor Plan 18</u>	463	
<u>Stout Floor Plan 19</u>	464	
<u>Stout Floor Plan 20</u>	407	467
<u>Stout Floor Plan 21</u>	413	473
	414	474
<u>Stout Floor Plan 22</u>	232	332
<u>Stout Floor Plan 23</u>	252	352

Floor Plan Type	Room Number
Iba	
<u>Community Floor Plan 1</u>	*01 *02 *03 *04 *05 *06 *07 *08 *09 *13 *14 *15 *16 *17 *18 *19 *20 *21 *22 *23 *24 *28 *29 *30
<u>Community Floor Plan 2</u>	*11 *26
<u>Community Floor Plan 3</u>	*10 *12 *25 *27

Floor Plan Type	Room Number
-----------------	-------------

Kerr - Drummond

<u>Community Floor Plan 1</u>	*01
	*02
	*03
	*04
	*05
	*06
	*07
	*08
	*09
	*13
	*14
	*15
	*16
	*17
	*18
	*19
	*20
	*21
	*22
	*23
	*24
	*25
	*29
	*30
	*31
	*32

<u>Community Floor Plan 2</u>	*11
	*27

<u>Community Floor Plan 3</u>	*10
	*12
	*26
	*28

Floor Plan Type	Room Number
<u>Community Floor Plan 1</u>	*02
	*03
	*04
	*05
	*06
	*07
	*08
	*09
	*10
	*11
	*12
	*13
	*17
	*18
	*19
	*20
	*21
*23	
*24	
*25	
*26	
*27	
*28	
<u>Community Floor Plan 2</u>	*15
	*30
<u>Community Floor Plan 3</u>	*01
	*14
	*16
	*29
<u>Community Floor Plan 4</u>	*22

Floor Plan Type	Room Number
Wentz	
<u>Community Floor Plan 1</u>	*01 *02 *03 *04 *05 *06 *07 *08 *09 *13 *14 *15 *16 *17 *18 *19 *20 *21 *22 *23 *24 *25 *29 *30 *31 *32

<u>Community Floor Plan 2</u>	*11 *27
-------------------------------	------------

<u>Community Floor Plan 3</u>	*10 *12 *26 *28
-------------------------------	--------------------------

Suite Style



East Bennett

Room Number

<u>33</u>	<u>140</u>	<u>239</u>	<u>334</u>	<u>431</u>
<u>35</u>	<u>142</u>	<u>242</u>	<u>337</u>	<u>433</u>
<u>38</u>	<u>144</u>	<u>243</u>	<u>339</u>	<u>435</u>
<u>40</u>	<u>147</u>	<u>245</u>	<u>342</u>	<u>438</u>
<u>42</u>	<u>150</u>	<u>247</u>	<u>343</u>	<u>440</u>
<u>44</u>	<u>151</u>	<u>250</u>	<u>345</u>	<u>443</u>
<u>47</u>	<u>154</u>	<u>253</u>	<u>347</u>	<u>444</u>
<u>54</u>	<u>157</u>	<u>254</u>	<u>350</u>	<u>447</u>
<u>109</u>	<u>209</u>	<u>257</u>	<u>353</u>	<u>449</u>
<u>111</u>	<u>211</u>	<u>259</u>	<u>354</u>	<u>452</u>
<u>113</u>	<u>213</u>	<u>309</u>	<u>357</u>	<u>454</u>
<u>114</u>	<u>214</u>	<u>311</u>	<u>359</u>	<u>455</u>
<u>116</u>	<u>216</u>	<u>313</u>	<u>409</u>	<u>458</u>
<u>118</u>	<u>218</u>	<u>314</u>	<u>411</u>	<u>460</u>
<u>120</u>	<u>220</u>	<u>316</u>	<u>413</u>	
<u>122</u>	<u>222</u>	<u>318</u>	<u>414</u>	
<u>123</u>	<u>223</u>	<u>320</u>	<u>416</u>	
<u>125</u>	<u>225</u>	<u>322</u>	<u>418</u>	
<u>127</u>	<u>227</u>	<u>323</u>	<u>420</u>	
<u>132</u>	<u>231</u>	<u>325</u>	<u>422</u>	
<u>134</u>	<u>232</u>	<u>327</u>	<u>423</u>	
<u>136</u>	<u>234</u>	<u>331</u>	<u>425</u>	
<u>139</u>	<u>237</u>	<u>332</u>	<u>427</u>	

East Bennett Floor Plan 1

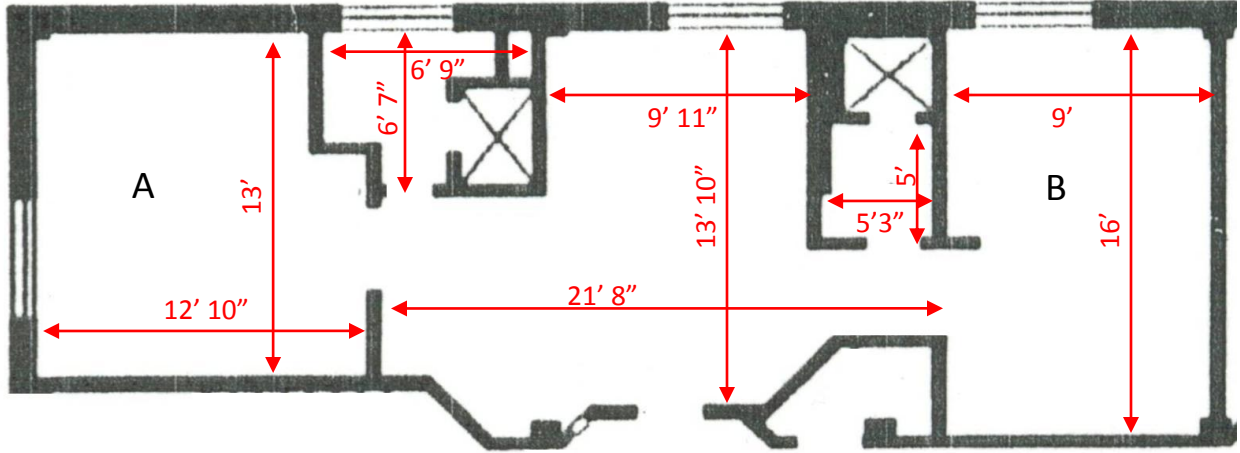

*Room floor plans may be mirror image depending on location.

*All Dimensions are approximate and may vary from room to room.

1st Floor - 45" x 73" Windows
Ground, 2nd and 3rd Floor - 45" x 65" Windows

In suites 38, 139, 150, 242, 253, 342, and 353 the "A" and "B" bedrooms are switched

East Bennett Floor Plan 2

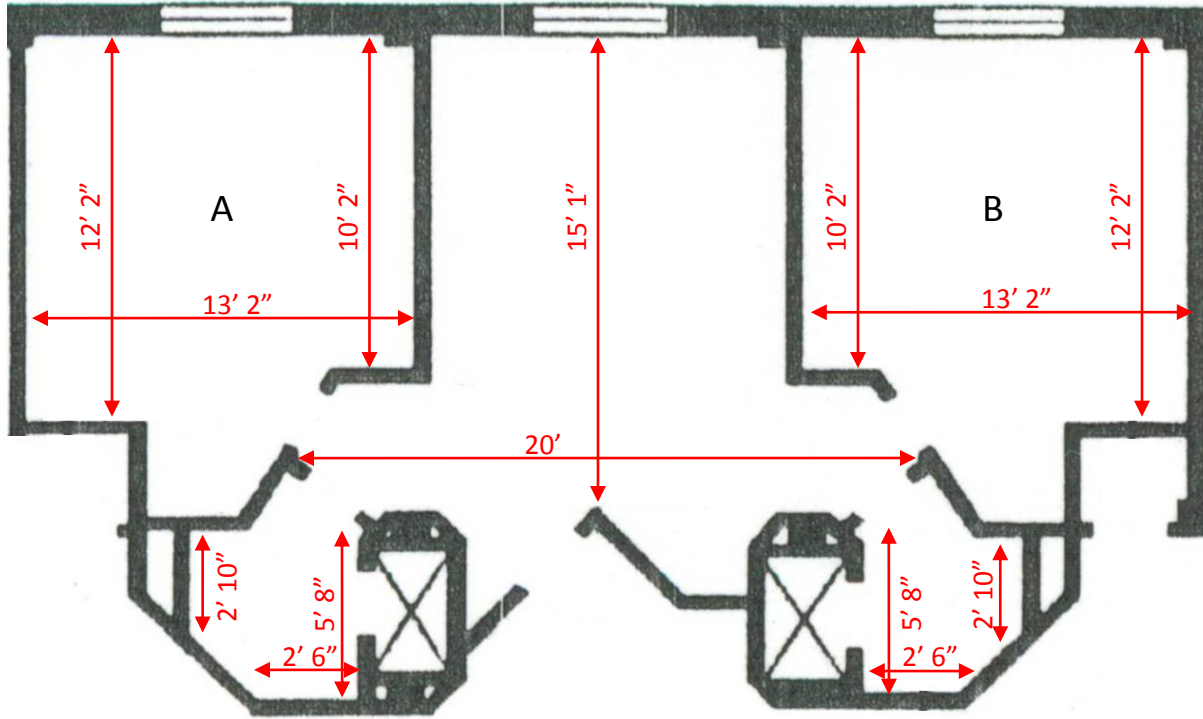

*Room floor plans may be mirror image depending on location.

*All Dimensions are approximate and may vary from room to room.

1st Floor - 45" x 73" Windows

Ground, 2nd and 3rd Floor - 45" x 65" Windows

4th Floor - 38" x 56" Windows

East Bennett Floor Plan 3

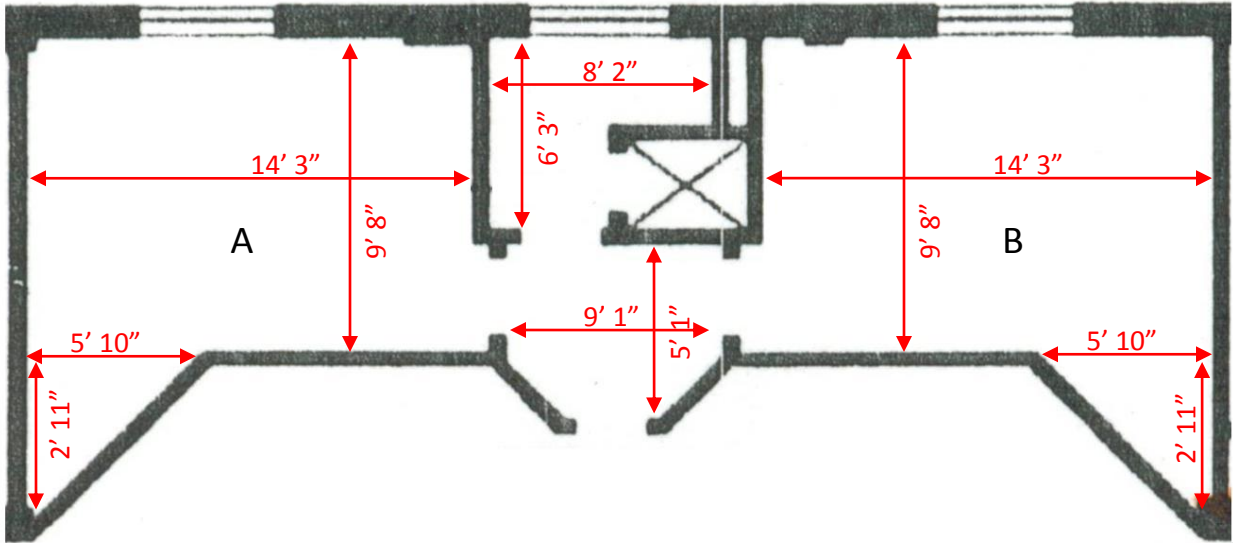

*Room floor plans may be mirror image depending on location.

*All Dimensions are approximate and may vary from room to room.

1st Floor - 45" x 73" Windows

Ground, 2nd and 3rd Floor - 45" x 65" Windows

East Bennett Floor Plan 4

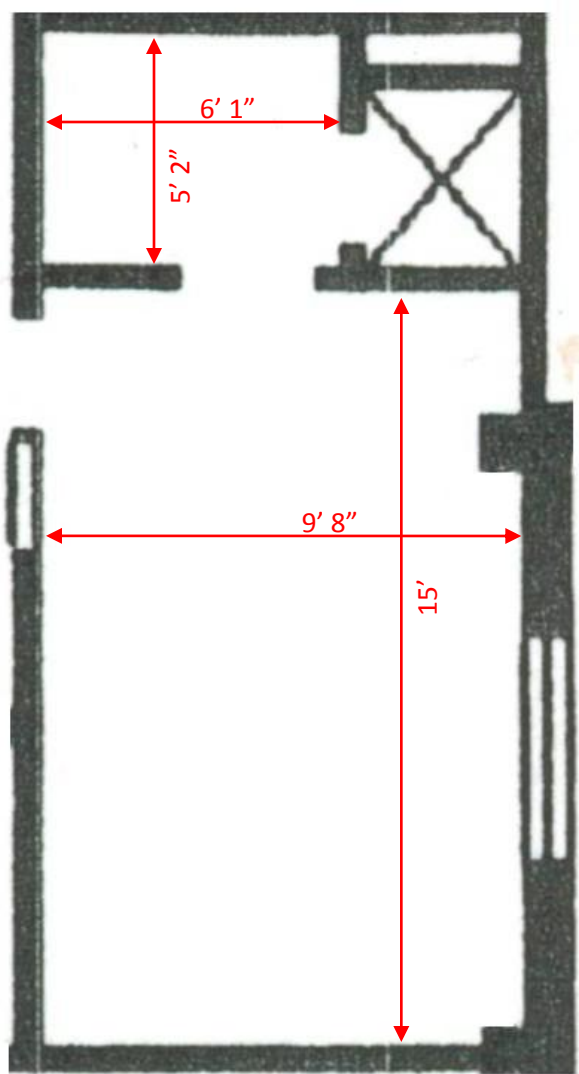

*Room floor plans may be mirror image depending on location.

*All Dimensions are approximate and may vary from room to room.

1st Floor - 45" x 73" Windows
Ground, 2nd and 3rd Floor - 45" x 65" Windows

East Bennett Floor Plan 5

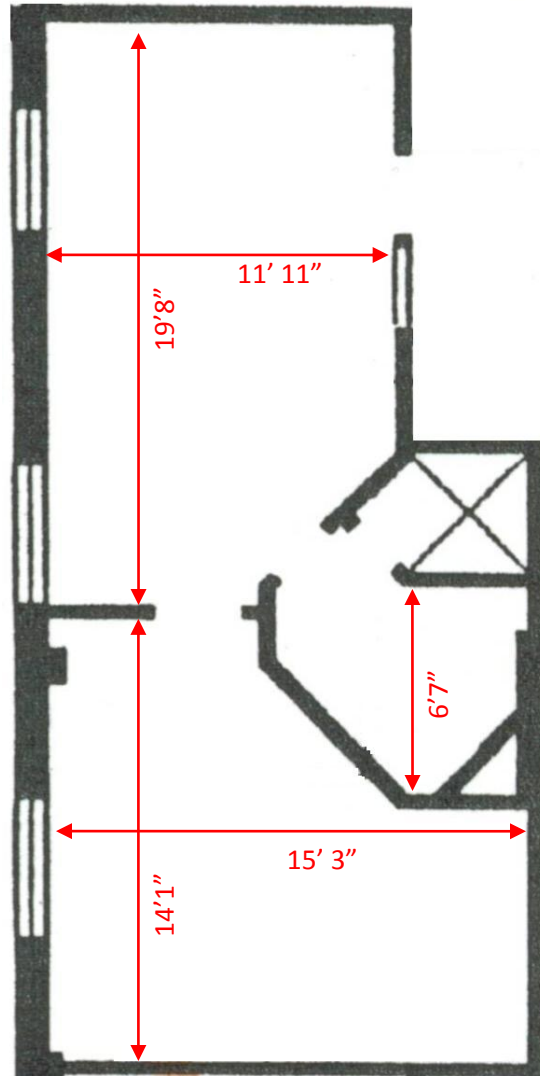

*Room floor plans may be mirror image depending on location.

*All Dimensions are approximate and may vary from room to room.

1st Floor - 45" x 73" Windows

East Bennett Floor Plan 6

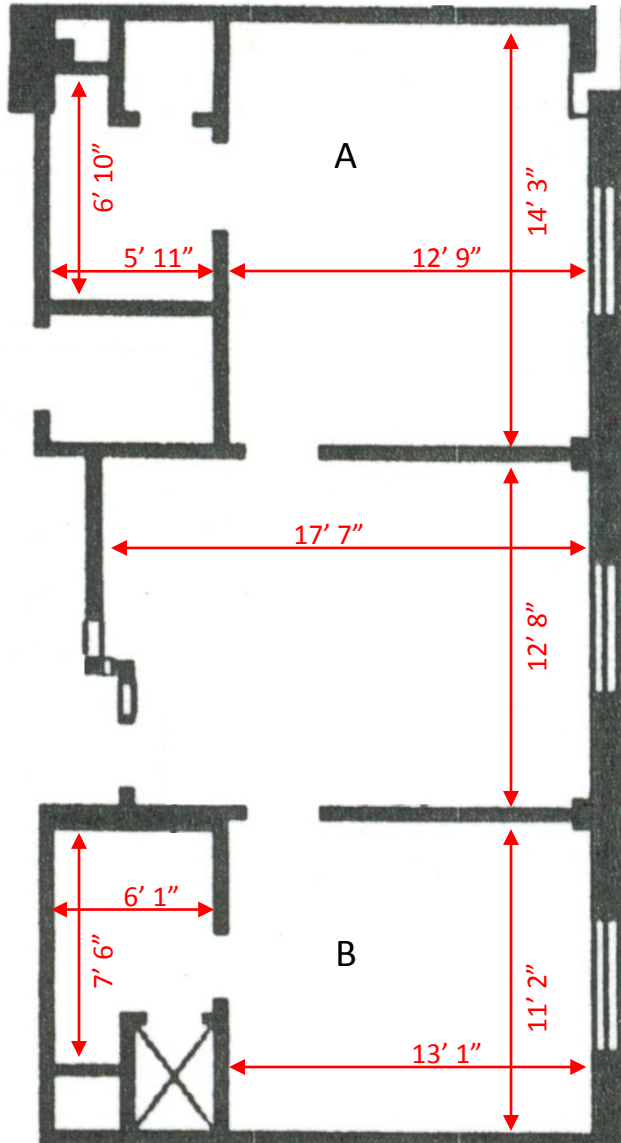

*Room floor plans may be mirror image depending on location.

*All Dimensions are approximate and may vary from room to room.

1st Floor - 45" x 73" Windows

East Bennett Floor Plan 7

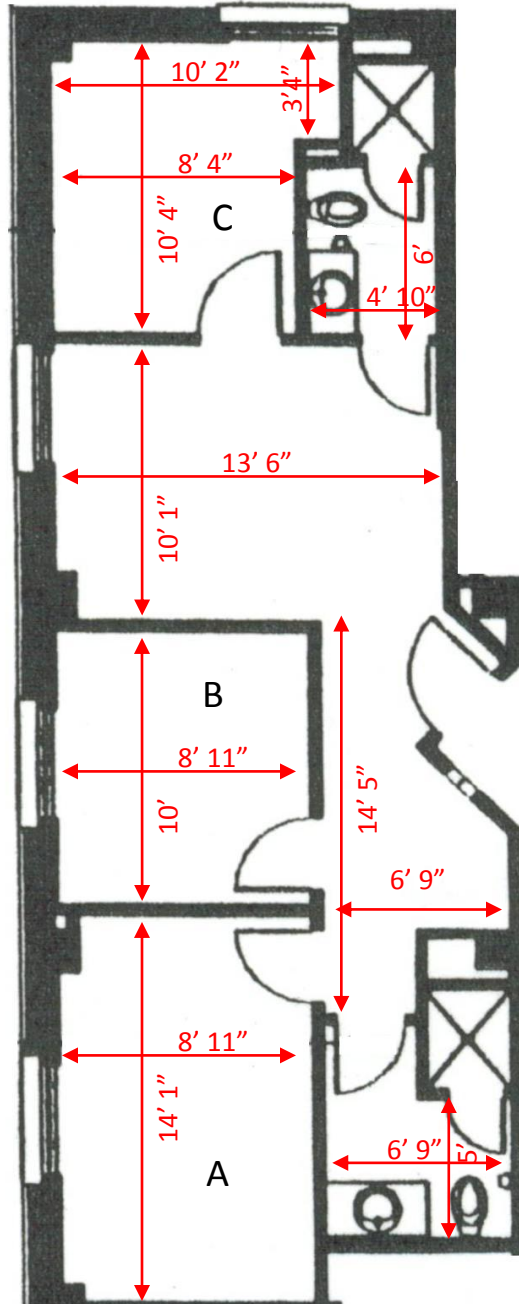

*Room floor plans may be mirror image depending on location.

*All Dimensions are approximate and may vary from room to room.

In suites 114, 123, 214, 223, 314, and 323 the "A" and "C" bedrooms are switched

1st Floor - 45" x 73" Windows
2nd and 3rd Floor - 45" x 65" Windows

East Bennett Floor Plan 8

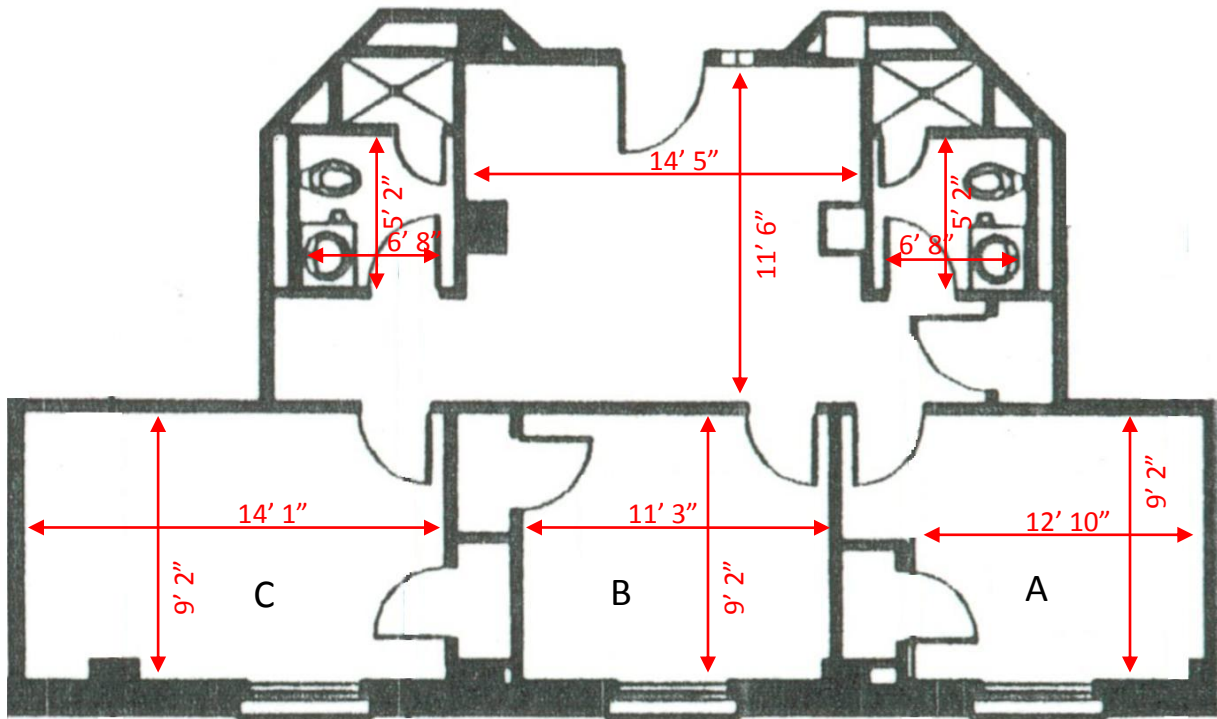

*Room floor plans may be mirror image depending on location.

*All Dimensions are approximate and may vary from room to room.

1st Floor - 45" x 73" Windows

2nd and 3rd Floor - 45" x 65" Windows

East Bennett Floor Plan 9

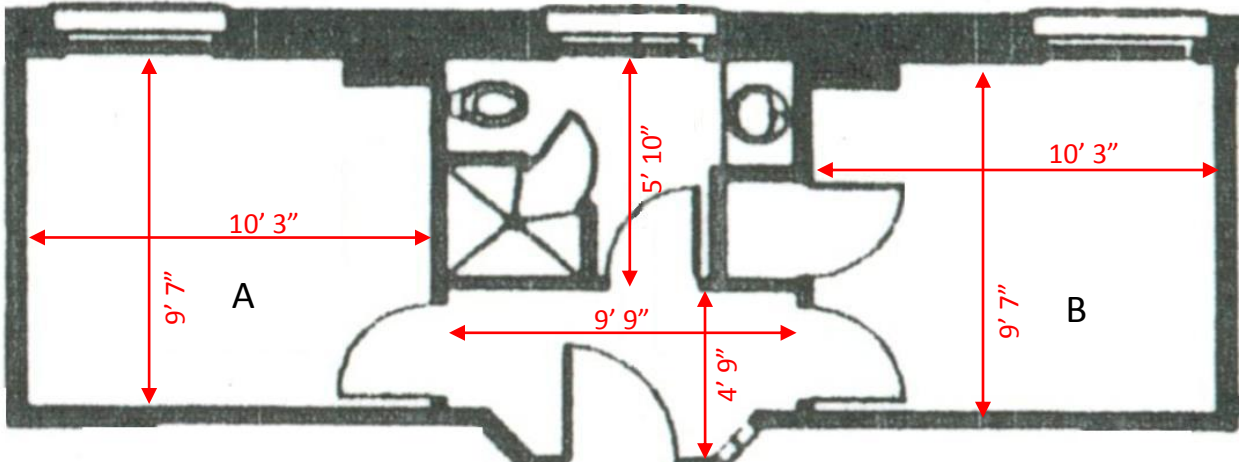

*Room floor plans may be mirror image depending on location.

*All Dimensions are approximate and may vary from room to room.

1st Floor - 45" x 73" Windows

2nd and 3rd Floor - 45" x 65" Windows

East Bennett Floor Plan 10

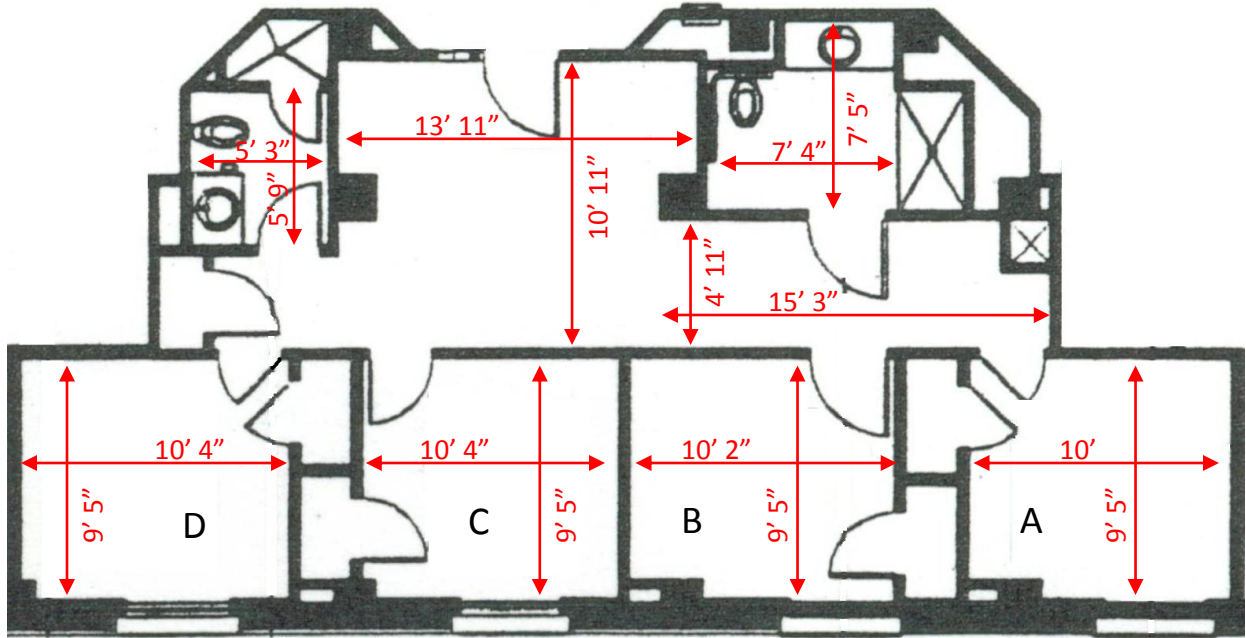

*Room floor plans may be mirror image depending on location.

*All Dimensions are approximate and may vary from room to room.

1st Floor - 45" x 73" Windows

2nd and 3rd Floor - 45" x 65" Windows

East Bennett Floor Plan 11

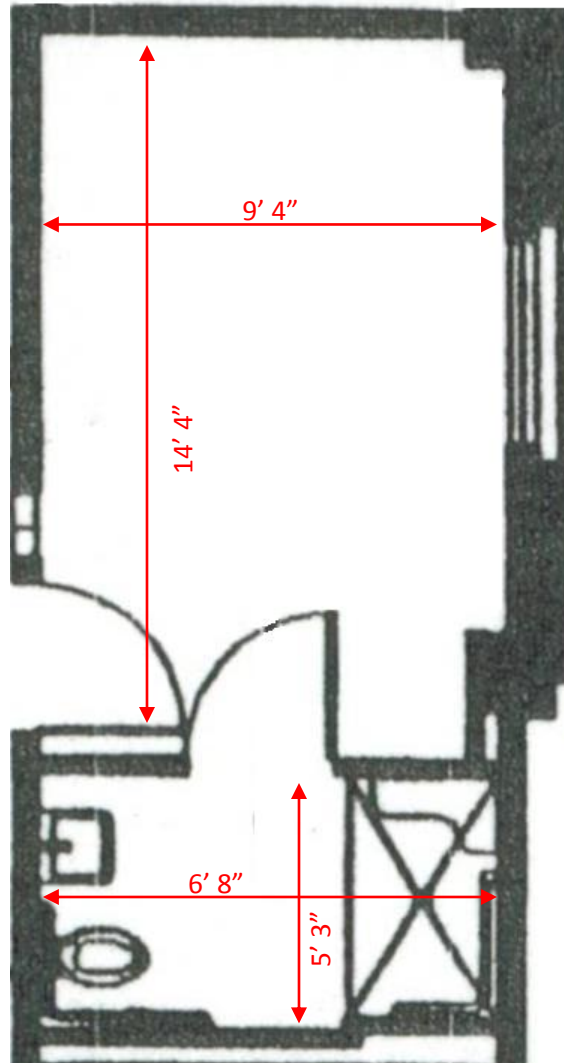

*Room floor plans may be mirror image depending on location.

*All Dimensions are approximate and may vary from room to room.

1st Floor - 45" x 73" Windows

2nd and 3rd Floor - 45" x 65" Windows

East Bennett Floor Plan 12

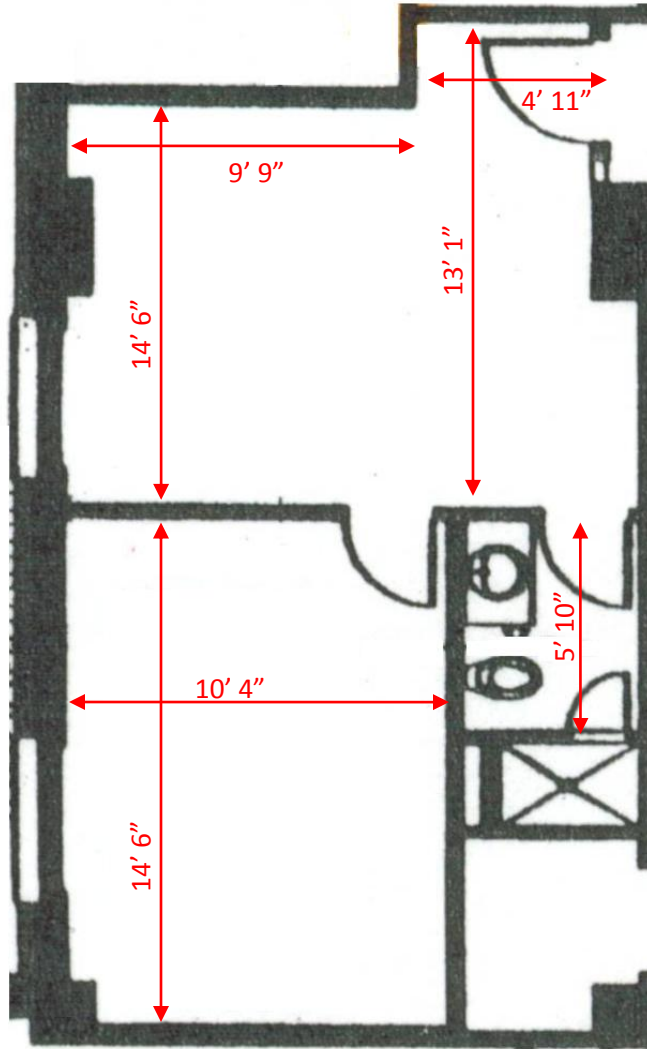

*Room floor plans may be mirror image depending on location.

*All Dimensions are approximate and may vary from room to room.

1st Floor - 45" x 73" Windows

East Bennett Floor Plan 13

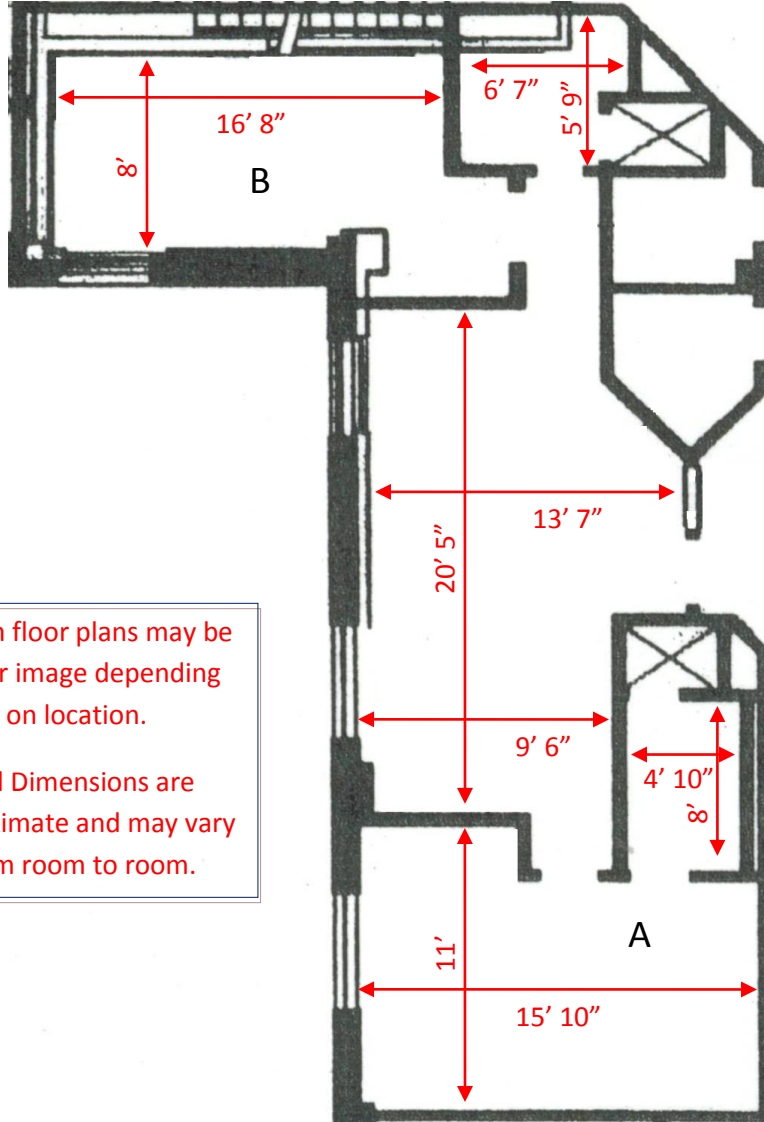

*Room floor plans may be mirror image depending on location.

*All Dimensions are approximate and may vary from room to room.

2nd and 3rd Floor - 45" x 65" Windows

East Bennett Floor Plan 14

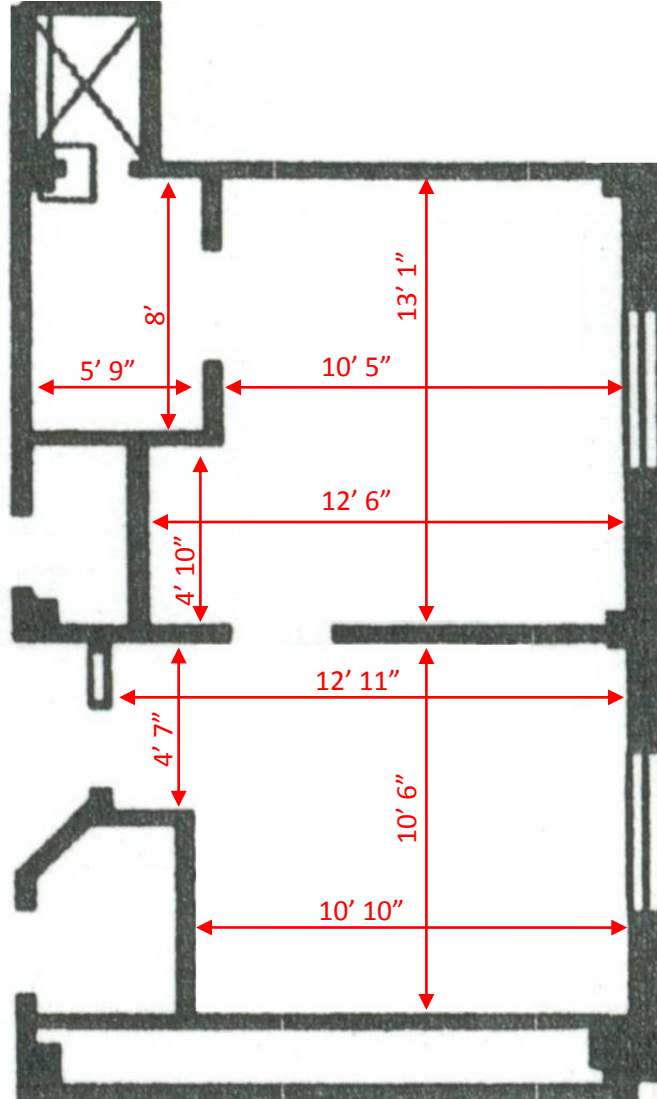

*Room floor plans may be mirror image depending on location.

*All Dimensions are approximate and may vary from room to room.

2nd and 3rd Floor - 45" x 65" Windows

East Bennett Floor Plan 15

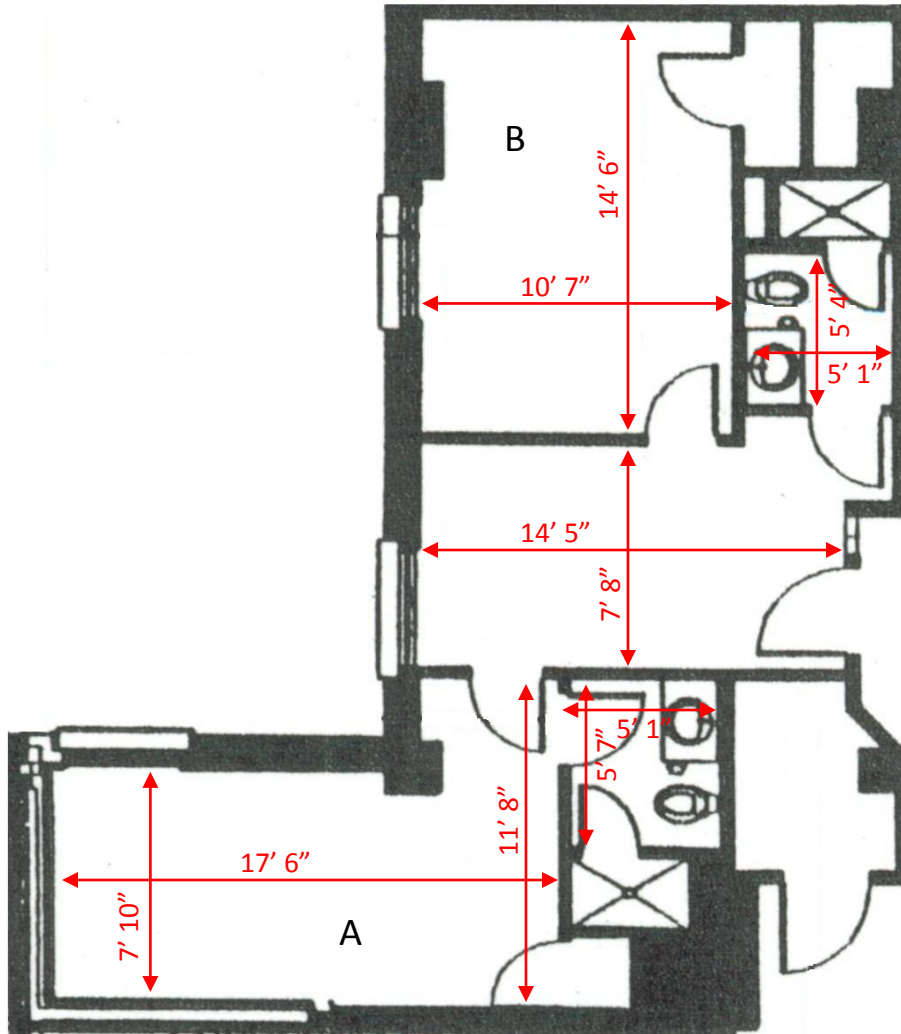

*Room floor plans may be mirror image depending on location.

*All Dimensions are approximate and may vary from room to room.

2nd and 3rd Floor - 45" x 65" Windows

East Bennett Floor Plan 16

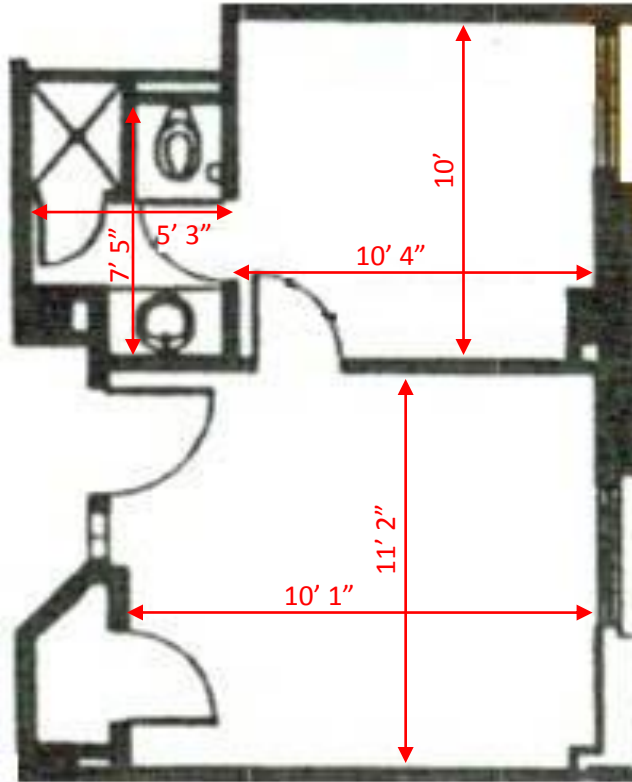

*Room floor plans may be mirror image depending on location.

*All Dimensions are approximate and may vary from room to room.

2nd and 3rd Floor - 45" x 65" Windows

East Bennett Floor Plan 17

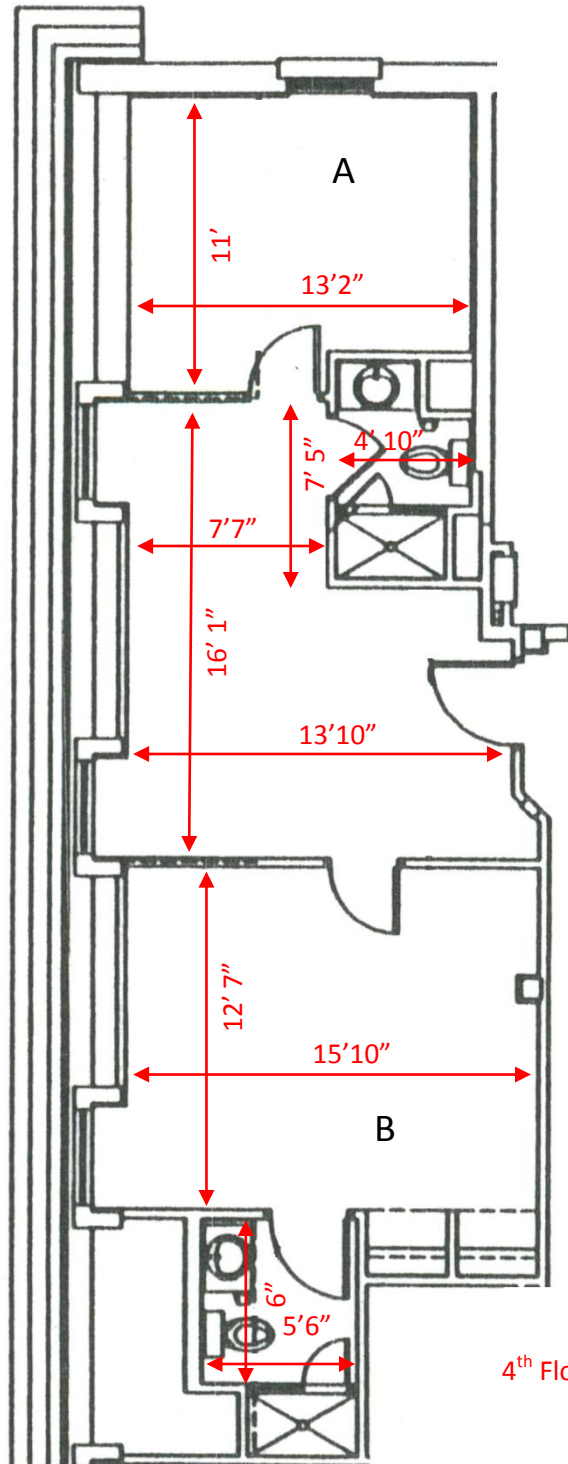

In suites 413 and 422 the "A" and "B" bedrooms are switched

*Room floor plans may be mirror image depending on location.
*All Dimensions are approximate and may vary from room to room.

4th Floor - 38" x 56" Windows

East Bennett Floor Plan 18

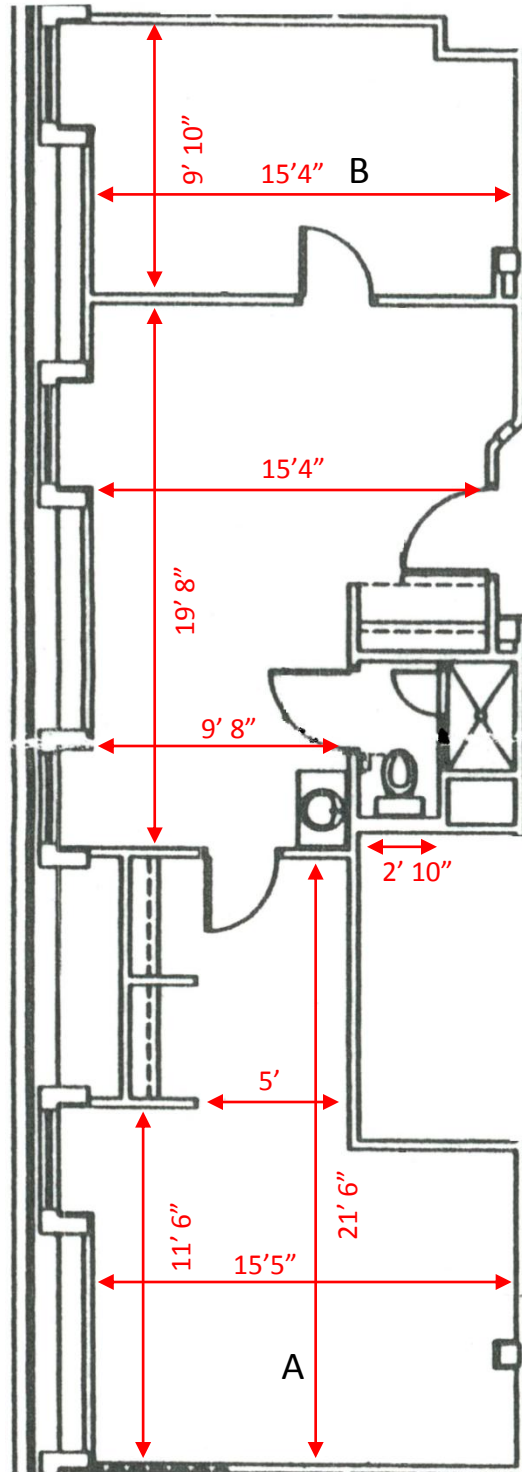

In suite 425 the "A" and "B" bedrooms are switched

*Room floor plans may be mirror image depending on location.

*All Dimensions are approximate and may vary from room to room.

4th Floor - 38" x 56" Windows

East Bennett Floor Plan 19

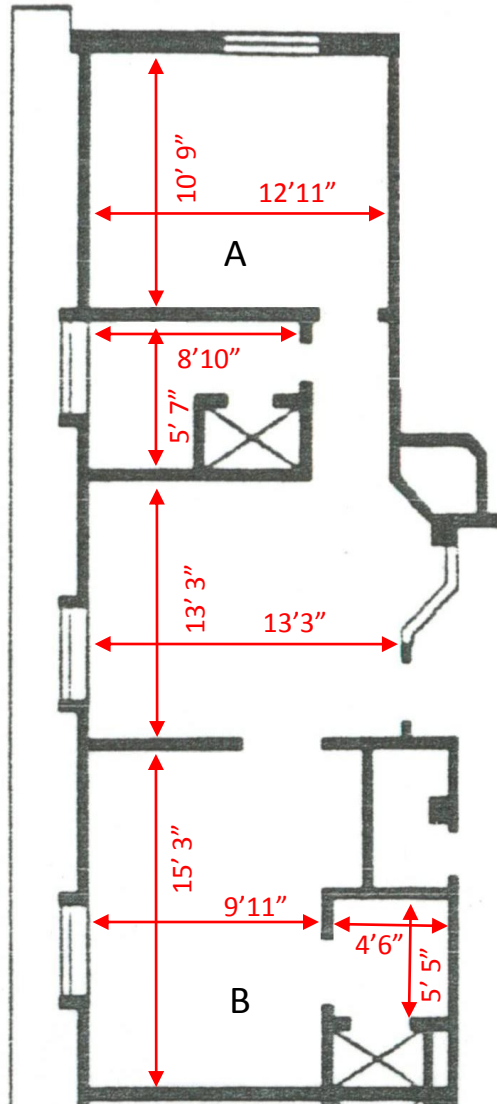

In suites 443 and 454 the "A" and "B" bedrooms are switched

*Room floor plans may be mirror image depending on location.
*All Dimensions are approximate and may vary from room to room.

4th Floor - 38" x 56" Windows

East Bennett Floor Plan 20

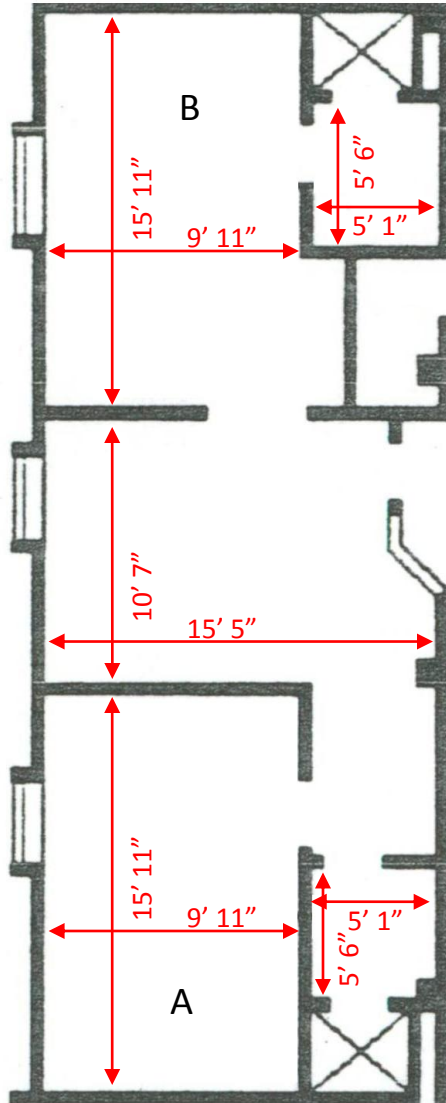

In suites 447 and 458 the "A" and "B" bedrooms are switched

*Room floor plans may be mirror image depending on location.
*All Dimensions are approximate and may vary from room to room.

4th Floor - 38" x 56" Windows

East Bennett Floor Plan 21

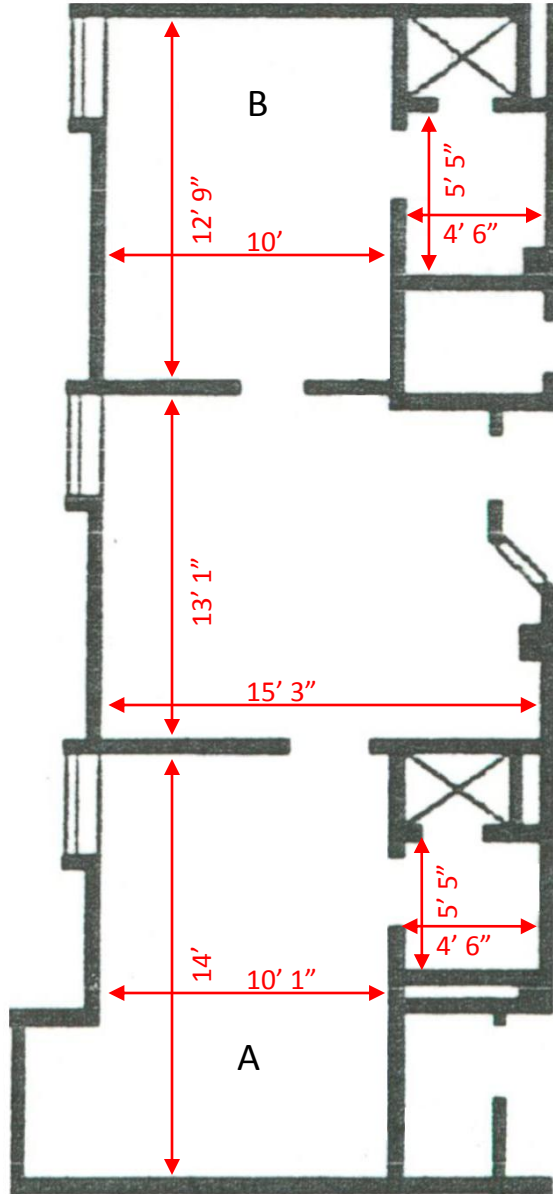

*Room floor plans may be mirror image depending on location.

*All Dimensions are approximate and may vary from room to room.

4th Floor - 38" x 56" Windows

East Bennett Floor Plan 22

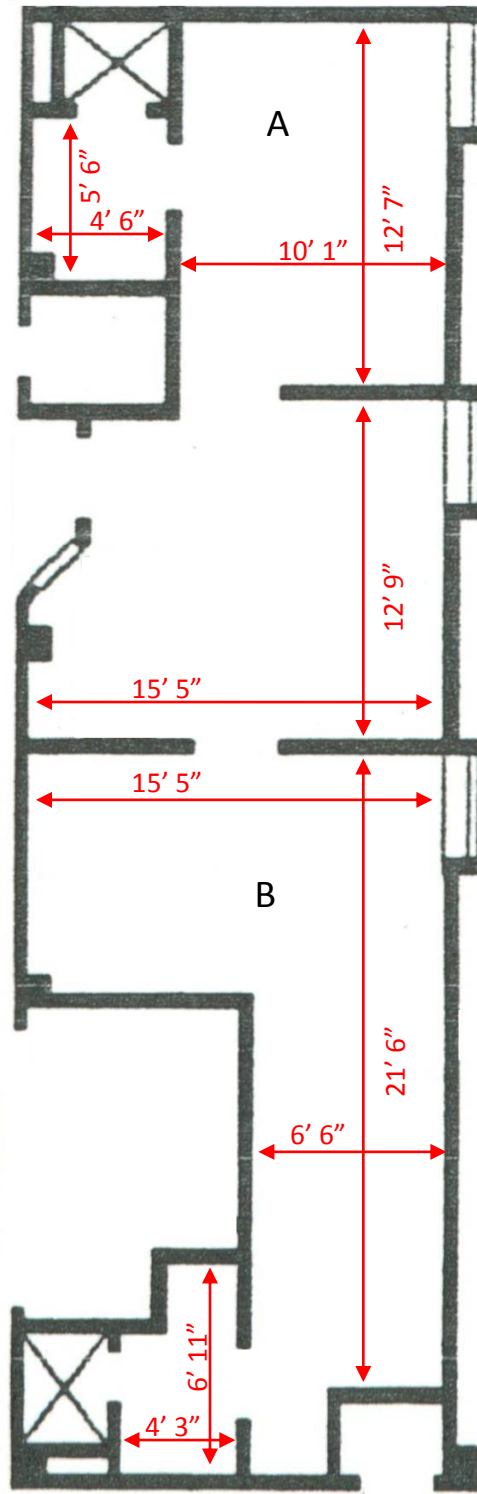

*Room floor plans may be mirror image depending on location.

*All Dimensions are approximate and may vary from room to room.

4th Floor - 38" x 56" Windows

East Bennett Floor Plan 23

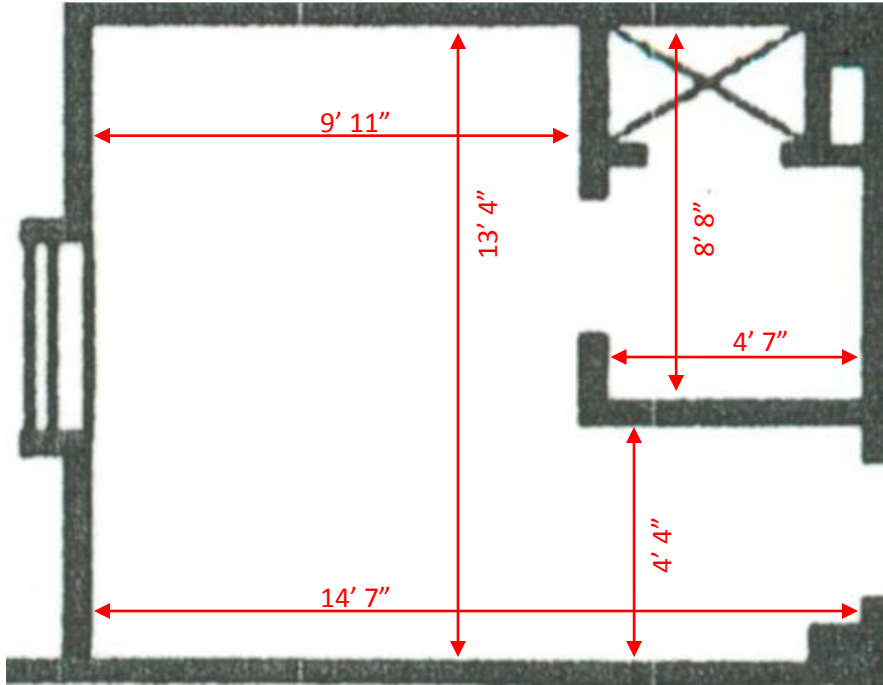

*Room floor plans may be mirror image depending on location.

*All Dimensions are approximate and may vary from room to room.

4th Floor - 38" x 56" Windows

East Bennett Floor Plan 24

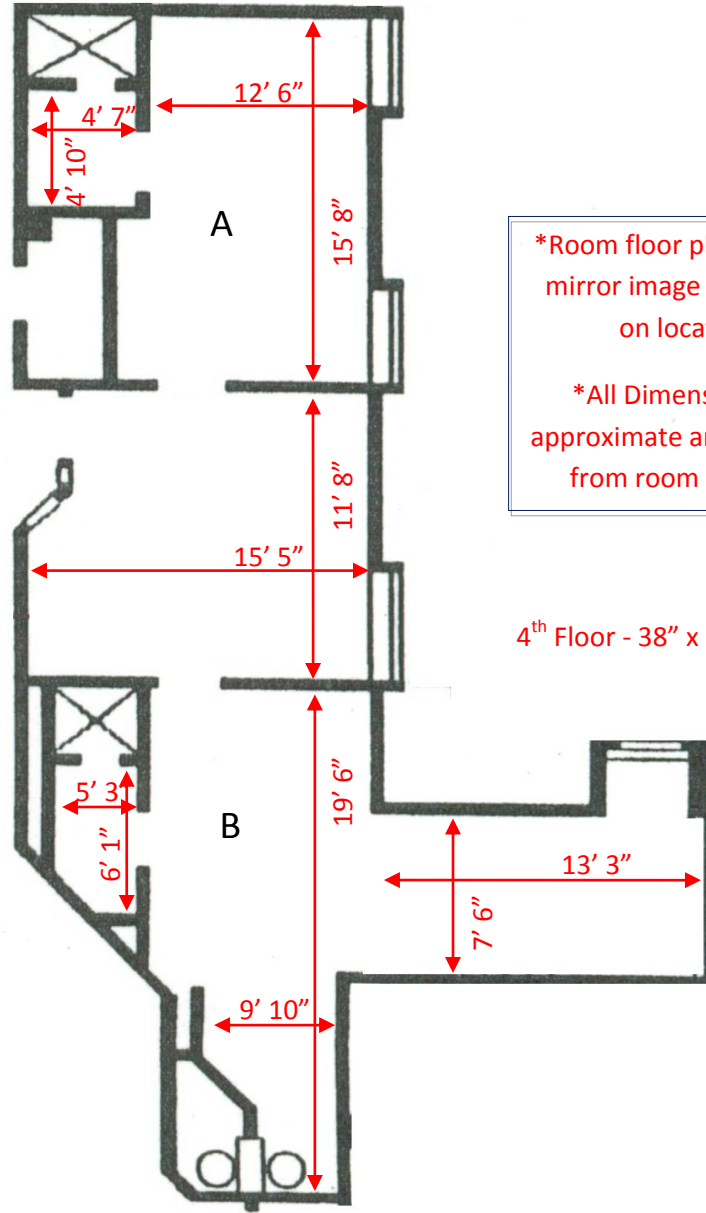

*Room floor plans may be mirror image depending on location.

*All Dimensions are approximate and may vary from room to room.

4th Floor - 38" x 56" Windows

East Bennett Floor Plan 25

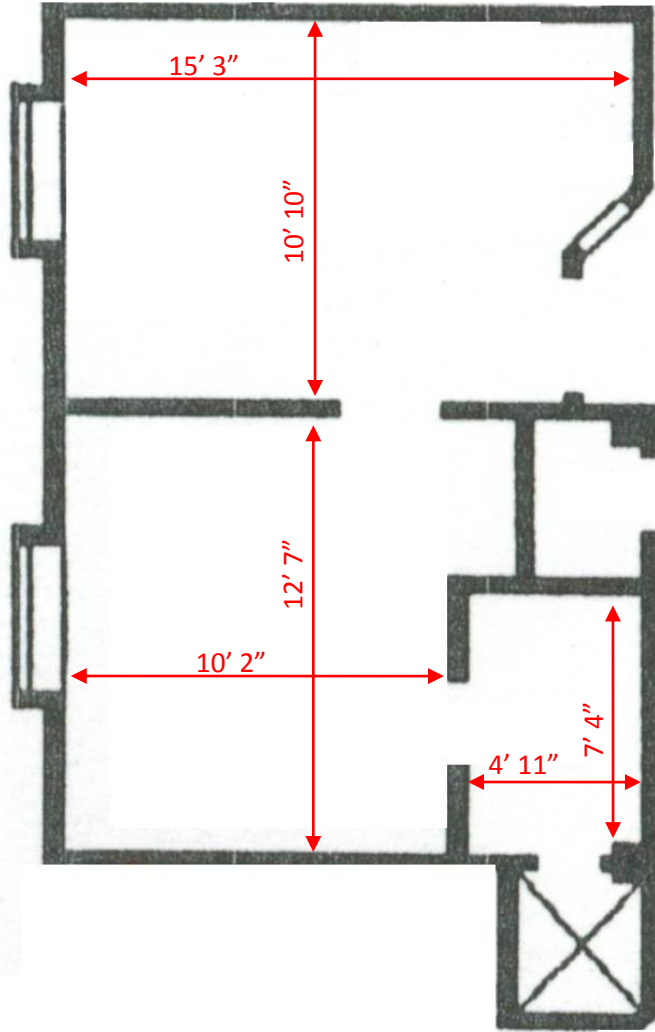

*Room floor plans may be mirror image depending on location.

*All Dimensions are approximate and may vary from room to room.

4th Floor - 38" x 56" Windows

East Bennett Floor Plan 26

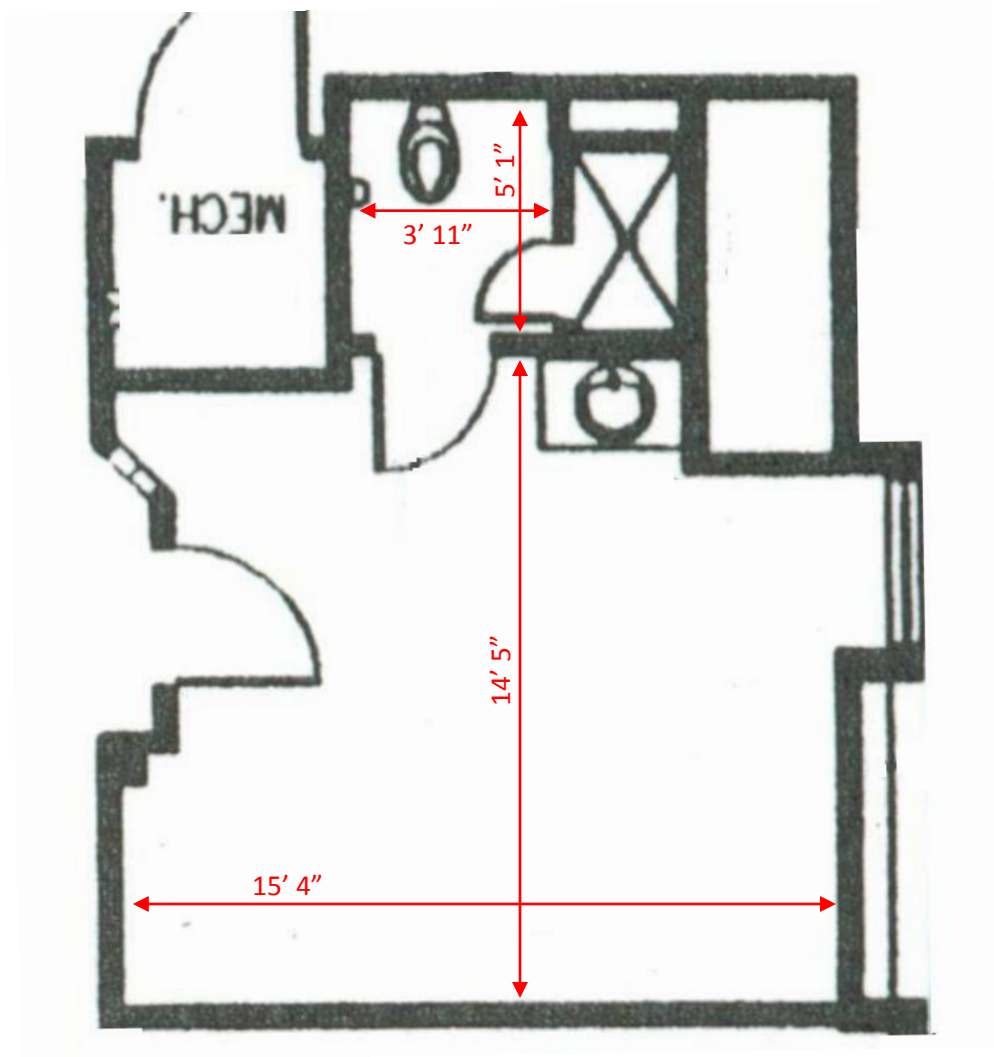

*Room floor plans may be mirror image depending on location.

*All Dimensions are approximate and may vary from room to room.

4th Floor - 38" x 56" Windows

East Bennett Floor Plan 27

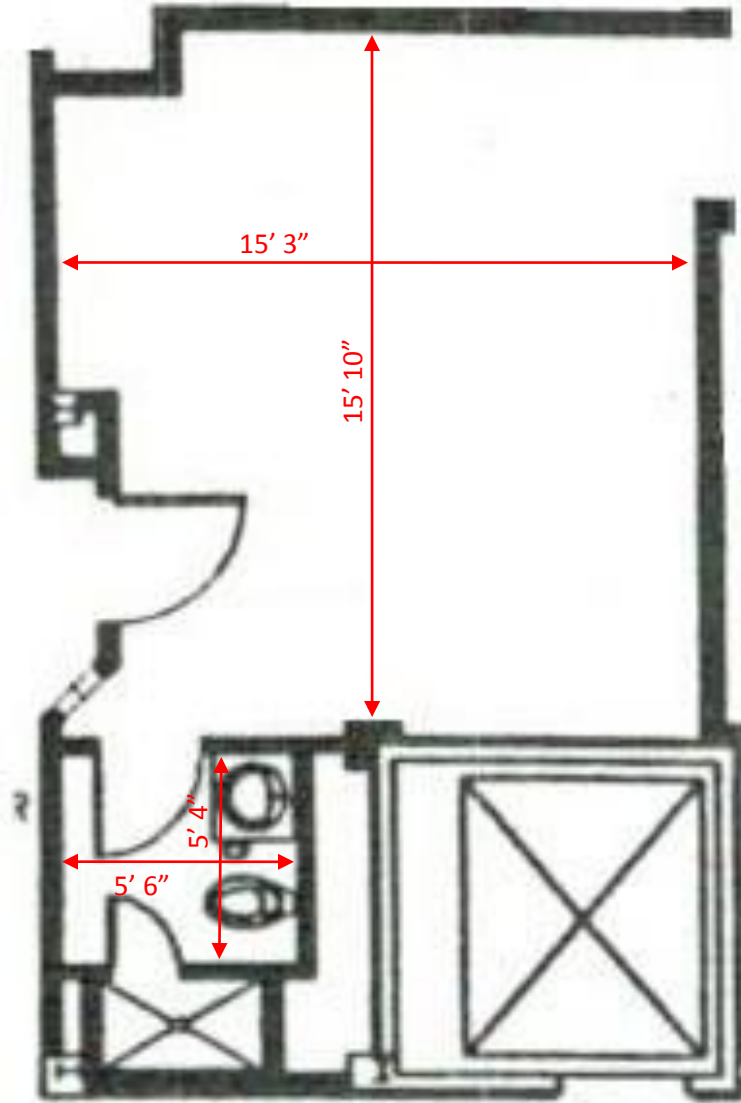

*Room floor plans may be mirror image depending on location.

*All Dimensions are approximate and may vary from room to room.

4th Floor - 38" x 56" Windows

East Bennett Floor Plan 28

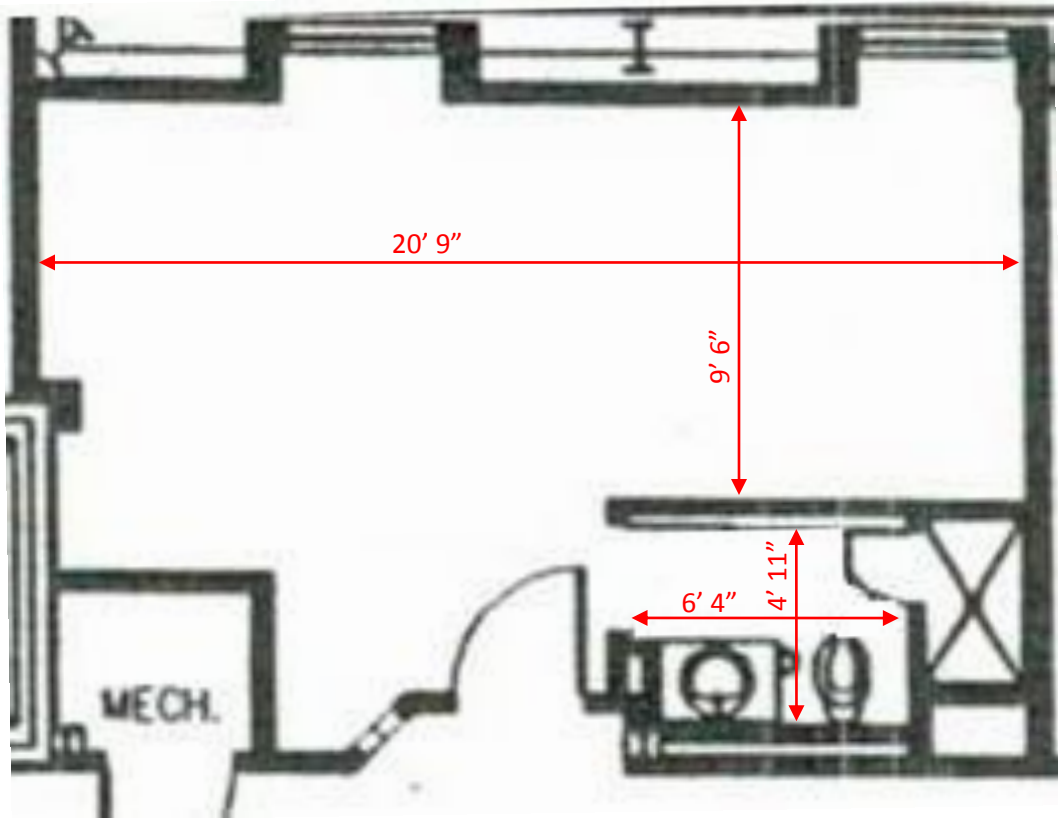

*Room floor plans may be mirror image depending on location.

*All Dimensions are approximate and may vary from room to room.

4th Floor - 38" x 56" Windows

East Bennett Floor Plan 29

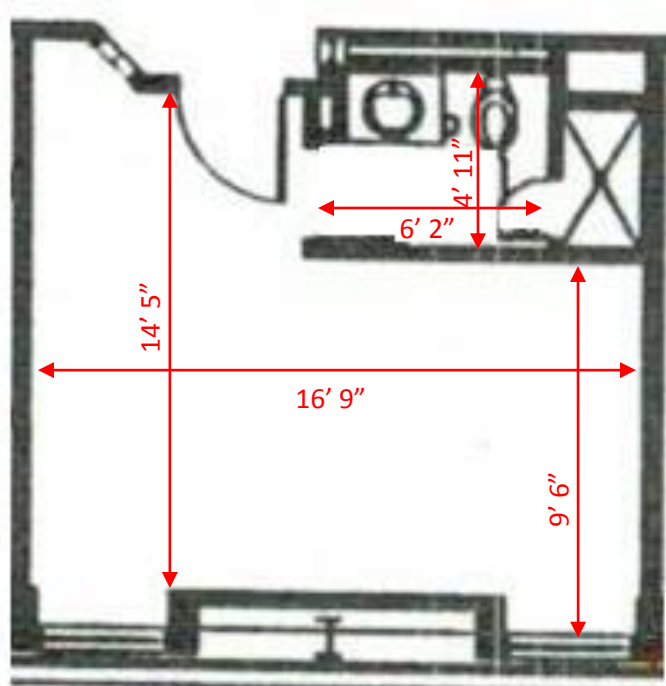

*Room floor plans may be mirror image depending on location.

*All Dimensions are approximate and may vary from room to room.

4th Floor - 38" x 56" Windows

East Bennett Floor Plan 30

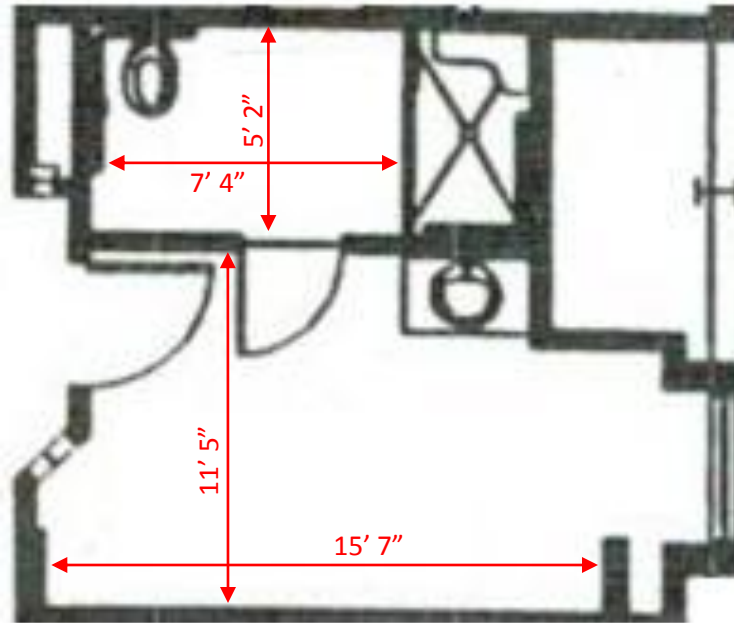

*Room floor plans may be mirror image depending on location.

*All Dimensions are approximate and may vary from room to room.

4th Floor - 38" x 56" Windows

Center Bennett

Room Number

<u>201</u>	<u>225</u>	<u>323</u>	<u>421</u>
<u>202</u>	<u>226</u>	<u>324</u>	<u>422</u>
<u>203</u>	<u>301</u>	<u>325</u>	<u>423</u>
<u>204</u>	<u>302</u>	<u>326</u>	<u>424</u>
<u>205</u>	<u>303</u>	<u>401</u>	<u>425</u>
<u>206</u>	<u>304</u>	<u>402</u>	<u>426</u>
<u>207</u>	<u>305</u>	<u>403</u>	
<u>208</u>	<u>306</u>	<u>404</u>	
<u>209</u>	<u>307</u>	<u>405</u>	
<u>210</u>	<u>308</u>	<u>406</u>	
<u>211</u>	<u>309</u>	<u>407</u>	
<u>212</u>	<u>310</u>	<u>408</u>	
<u>214</u>	<u>311</u>	<u>409</u>	
<u>215</u>	<u>312</u>	<u>410</u>	
<u>216</u>	<u>314</u>	<u>411</u>	
<u>217</u>	<u>315</u>	<u>412</u>	
<u>218</u>	<u>316</u>	<u>414</u>	
<u>219</u>	<u>317</u>	<u>415</u>	
<u>220</u>	<u>318</u>	<u>416</u>	
<u>221</u>	<u>319</u>	<u>417</u>	
<u>222</u>	<u>320</u>	<u>418</u>	
<u>223</u>	<u>321</u>	<u>419</u>	
<u>224</u>	<u>322</u>	<u>420</u>	

Center Bennett Floor Plan 1

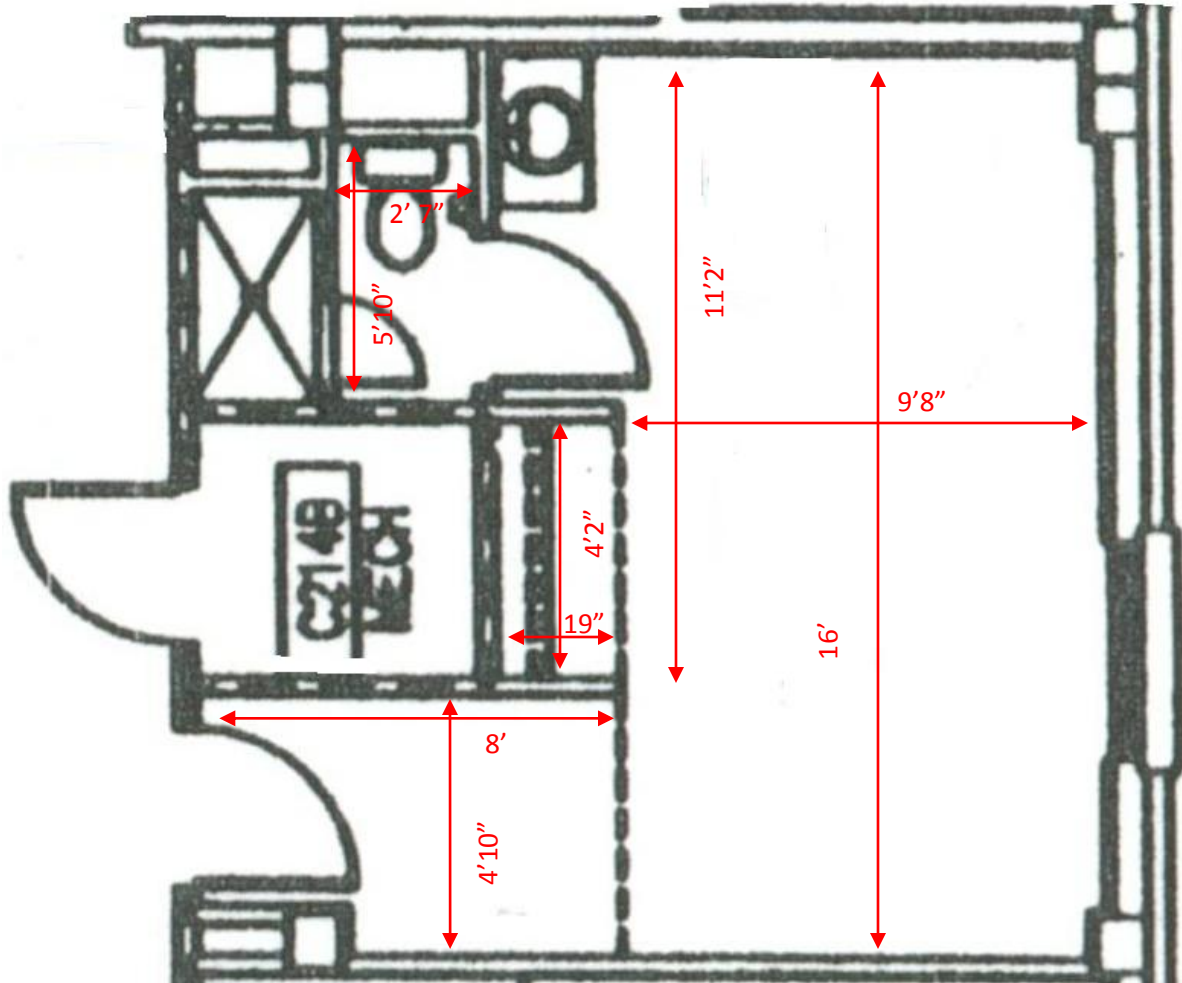

*Room floor plans may be mirror image depending on location.

*All Dimensions are approximate and may vary from room to room.

2nd and 3rd Floor - 45" x 65" Window

4th Floor - 38" x 56" Window

Center Bennett Floor Plan 2

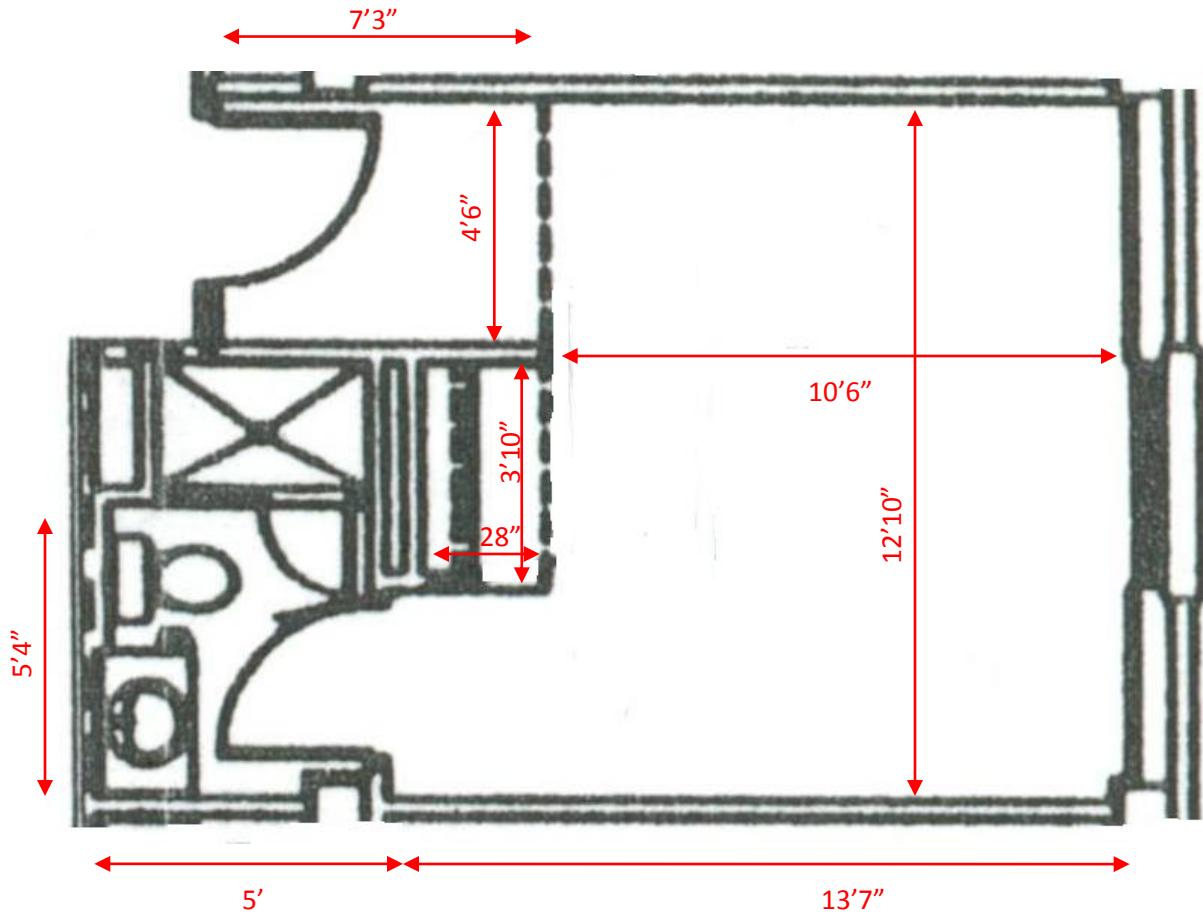

*Room floor plans may be mirror image depending on location.

*All Dimensions are approximate and may vary from room to room.

2nd and 3rd Floor - 45" x 65" Window
4th Floor - 38" x 56" Window

Center Bennett Floor Plan 3

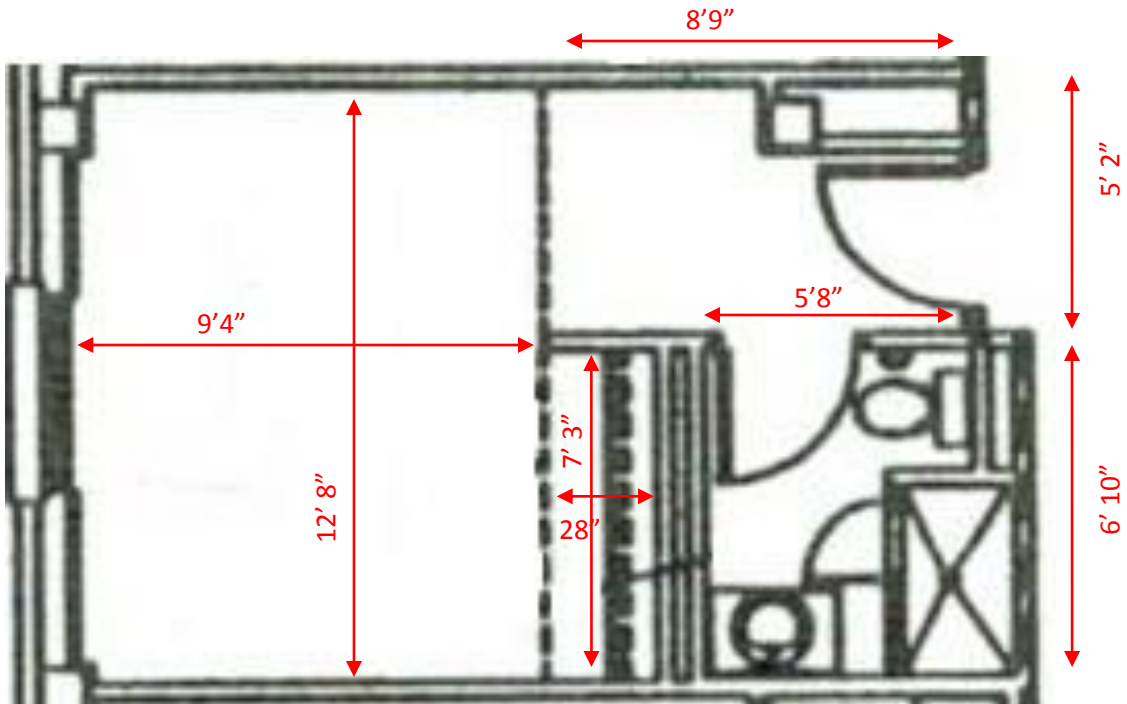

*Room floor plans may be mirror image depending on location.

*All Dimensions are approximate and may vary from room to room.

2nd and 3rd Floor - 45" x 65" Window
4th Floor - 38" x 56" Window

West Bennett

Room Number			
<u>109</u>	<u>211</u>	<u>313</u>	<u>423</u>
<u>111</u>	<u>213</u>	<u>314</u>	<u>425</u>
<u>113</u>	<u>214</u>	<u>316</u>	<u>427</u>
<u>114</u>	<u>216</u>	<u>320</u>	<u>429</u>
<u>116</u>	<u>218</u>	<u>322</u>	<u>432</u>
<u>118</u>	<u>220</u>	<u>323</u>	<u>434</u>
<u>120</u>	<u>222</u>	<u>327</u>	<u>436</u>
<u>122</u>	<u>223</u>	<u>329</u>	<u>439</u>
<u>123</u>	<u>225</u>	<u>332</u>	<u>440</u>
<u>125</u>	<u>227</u>	<u>334</u>	<u>442</u>
<u>127</u>	<u>229</u>	<u>336</u>	<u>444</u>
<u>129</u>	<u>232</u>	<u>339</u>	<u>447</u>
<u>132</u>	<u>234</u>	<u>342</u>	<u>450</u>
<u>134</u>	<u>236</u>	<u>344</u>	<u>451</u>
<u>136</u>	<u>239</u>	<u>347</u>	<u>454</u>
<u>139</u>	<u>240</u>	<u>354</u>	<u>457</u>
<u>140</u>	<u>242</u>	<u>357</u>	
<u>142</u>	<u>244</u>	<u>409</u>	
<u>144</u>	<u>247</u>	<u>411</u>	
<u>147</u>	<u>250</u>	<u>413</u>	
<u>150</u>	<u>251</u>	<u>414</u>	
<u>151</u>	<u>254</u>	<u>416</u>	
<u>154</u>	<u>257</u>	<u>418</u>	
<u>157</u>	<u>309</u>	<u>420</u>	
<u>209</u>	<u>311</u>	<u>422</u>	

West Bennett Floor Plan 1

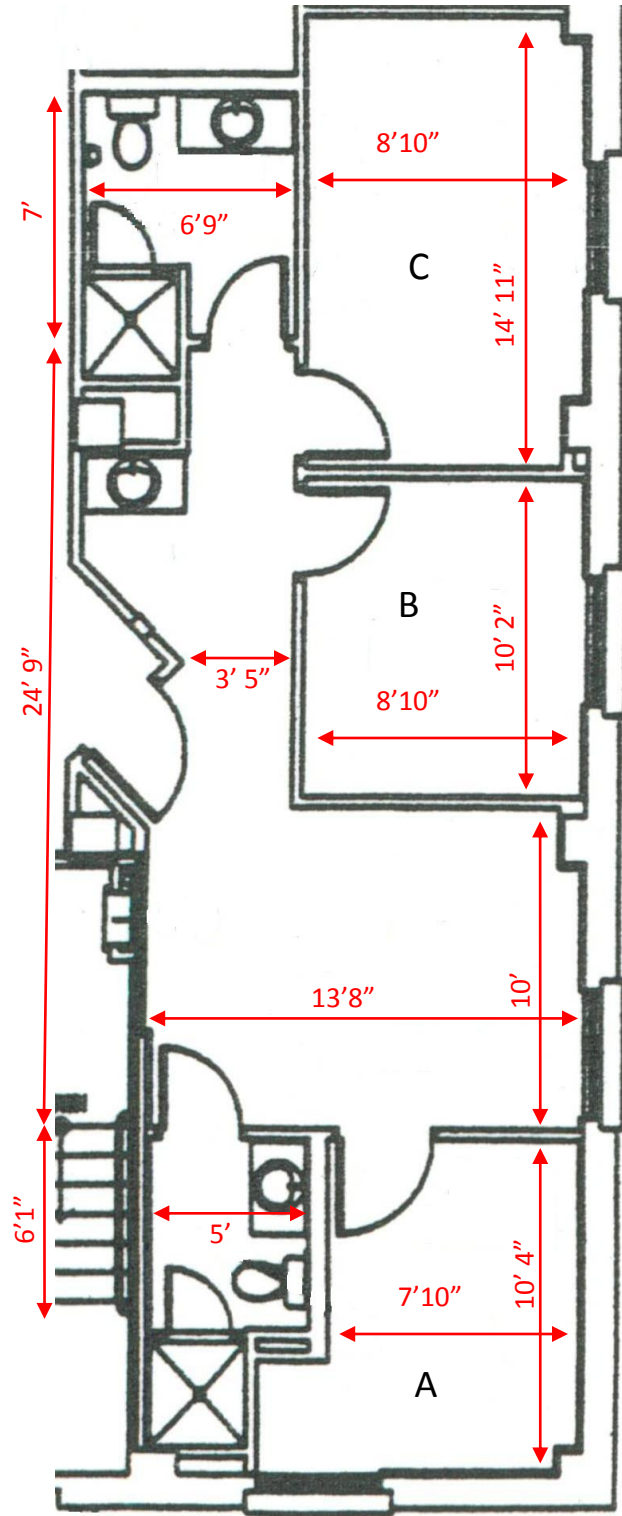

1st Floor - 45" x 73" Windows
2nd and 3rd Floor - 45" x 65" Windows

*Room floor plans may be mirror image depending on location.
*All Dimensions are approximate and may vary from room to room.

West Bennett Floor Plan 2

1st Floor - 45" x 73" Windows

2nd and 3rd Floor - 45" x 65" Windows

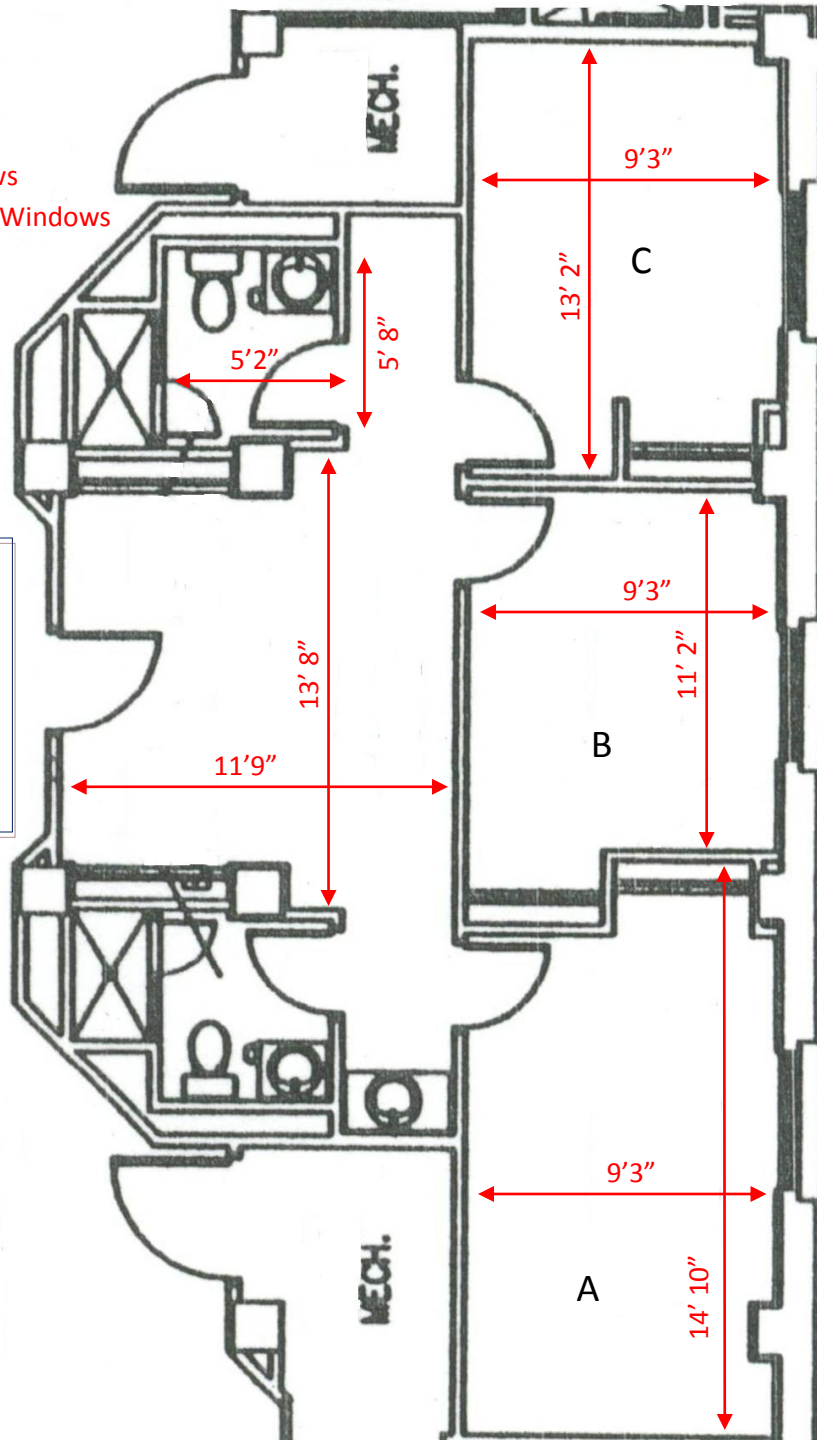

*Room floor plans may be mirror image depending on location.

*All Dimensions are approximate and may vary from room to room.

West Bennett Floor Plan 3

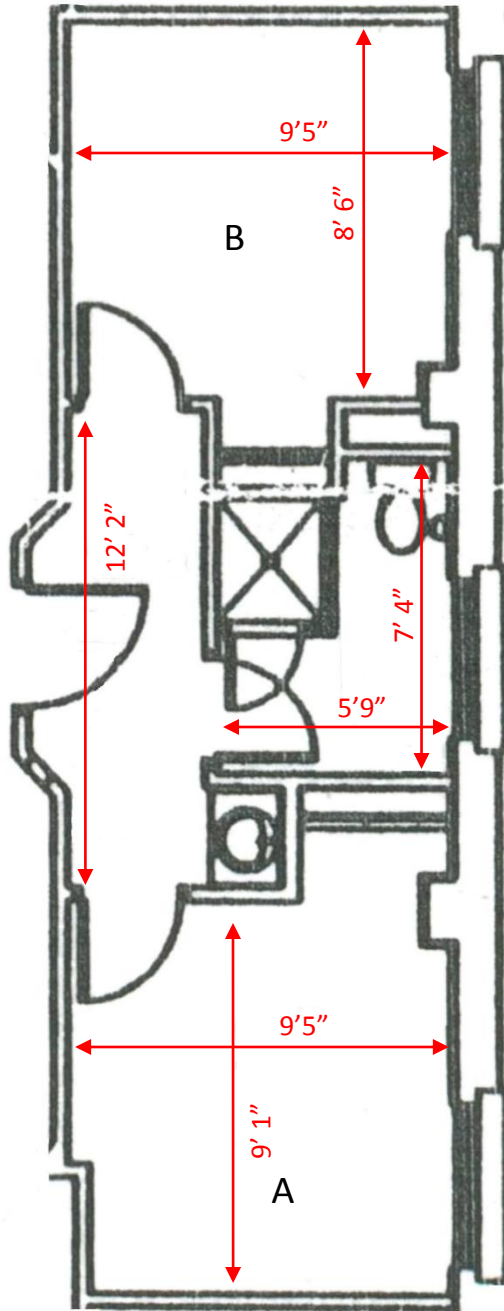

1st Floor - 45" x 73" Windows
2nd and 3rd Floor - 45" x 65" Windows

*Room floor plans may be mirror image depending on location.
*All Dimensions are approximate and may vary from room to room.

West Bennett Floor Plan 4

1st Floor - 45" x 73" Windows
2nd and 3rd Floor - 45" x 65" Windows

*Room floor plans may be mirror image depending on location.

*All Dimensions are approximate and may vary from room to room.

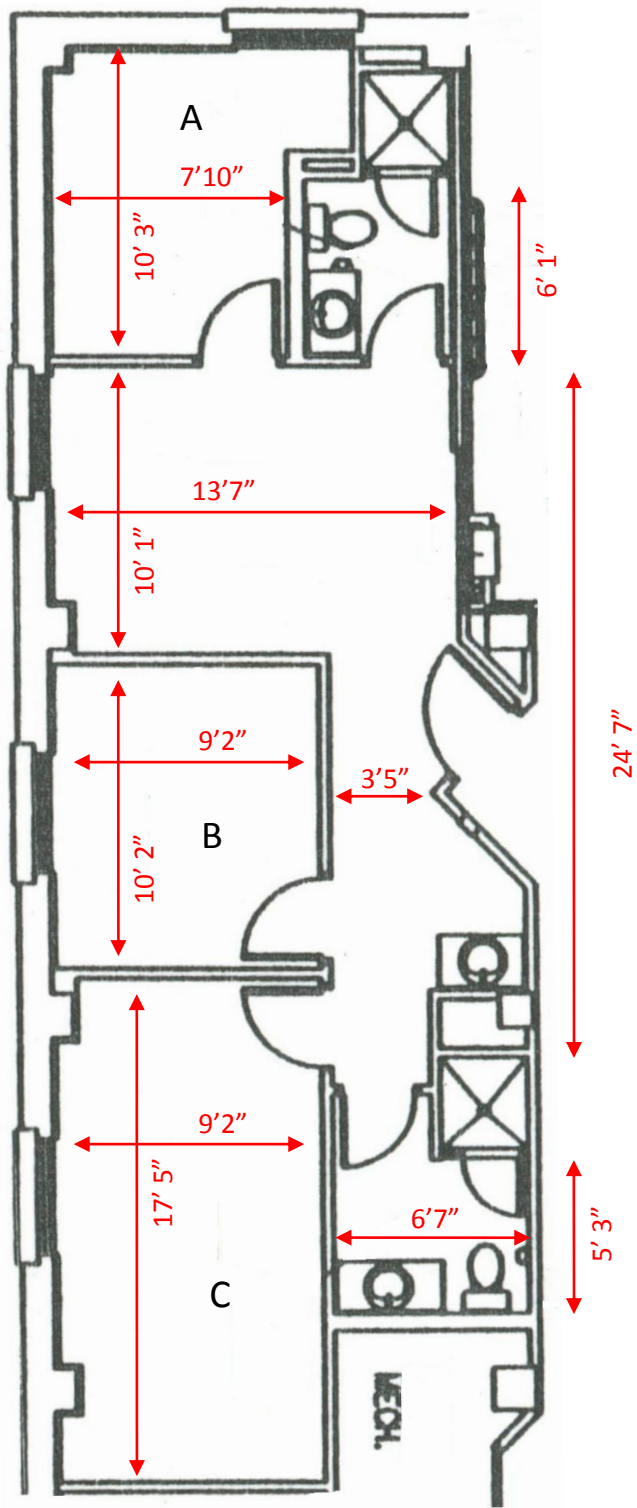

West Bennett Floor Plan 5

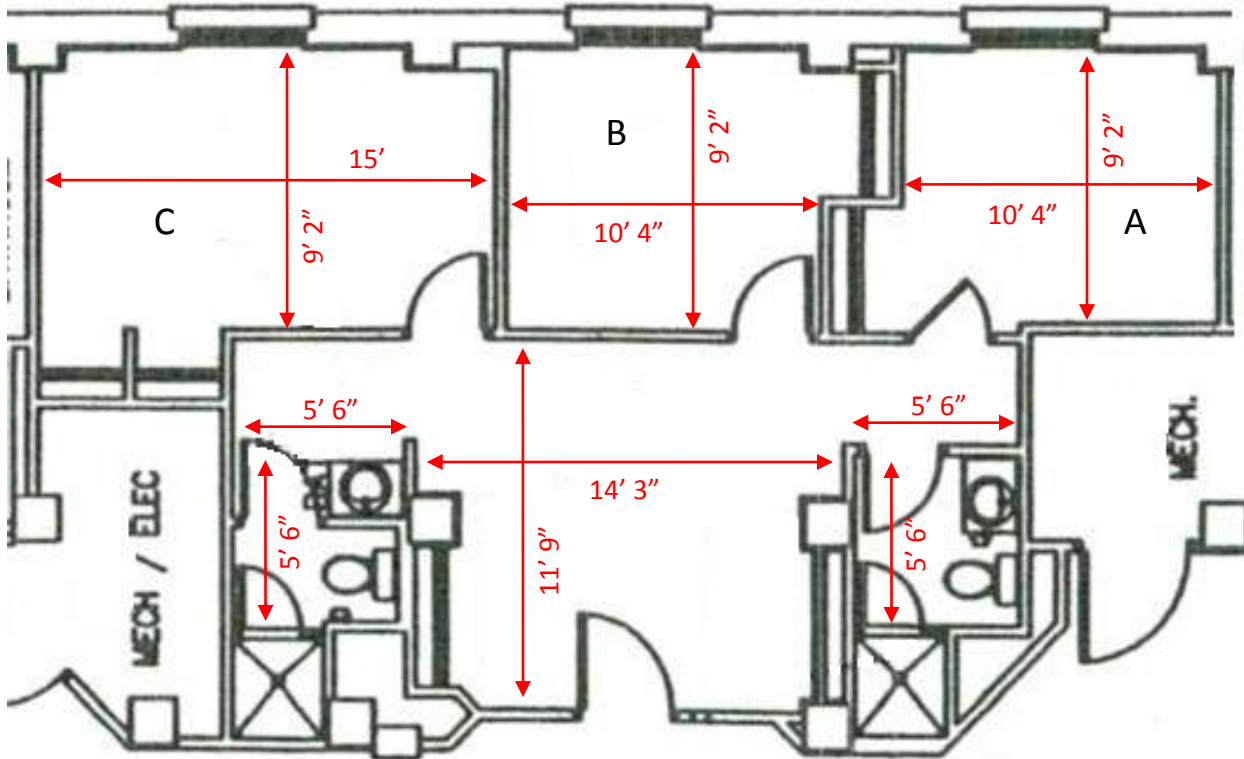

*Room floor plans may be mirror image depending on location.

*All Dimensions are approximate and may vary from room to room.

1st Floor - 45" x 73" Windows

West Bennett Floor Plan 6

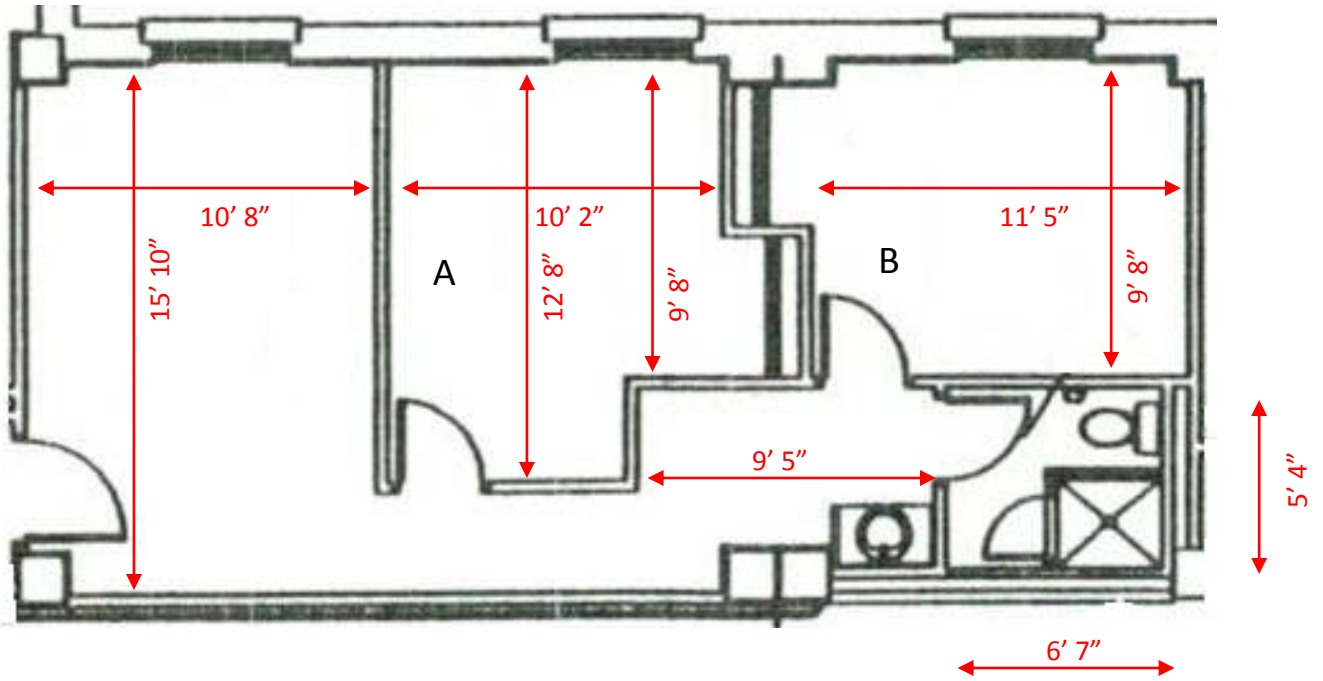

*Room floor plans may be mirror image depending on location.

*All Dimensions are approximate and may vary from room to room.

1st Floor - 45" x 73" Windows

West Bennett Floor Plan 7

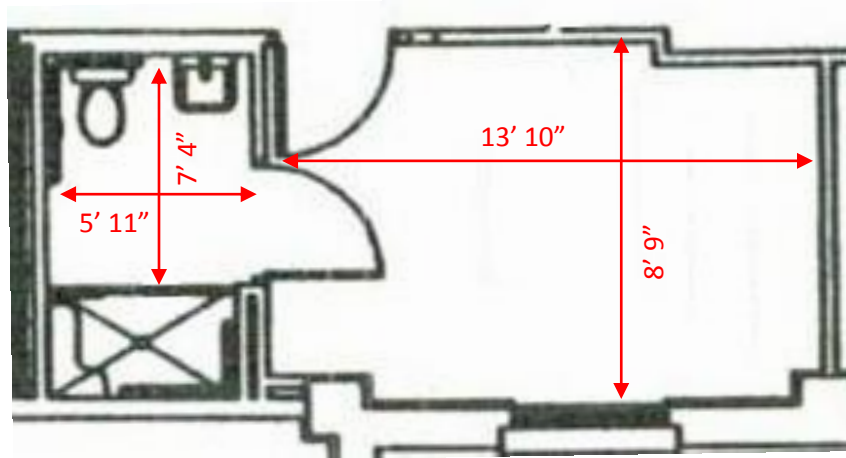

*Room floor plans may be mirror image depending on location.

*All Dimensions are approximate and may vary from room to room.

1st Floor - 45" x 73" Windows
2nd and 3rd Floor - 45" x 65" Windows

West Bennett Floor Plan 8

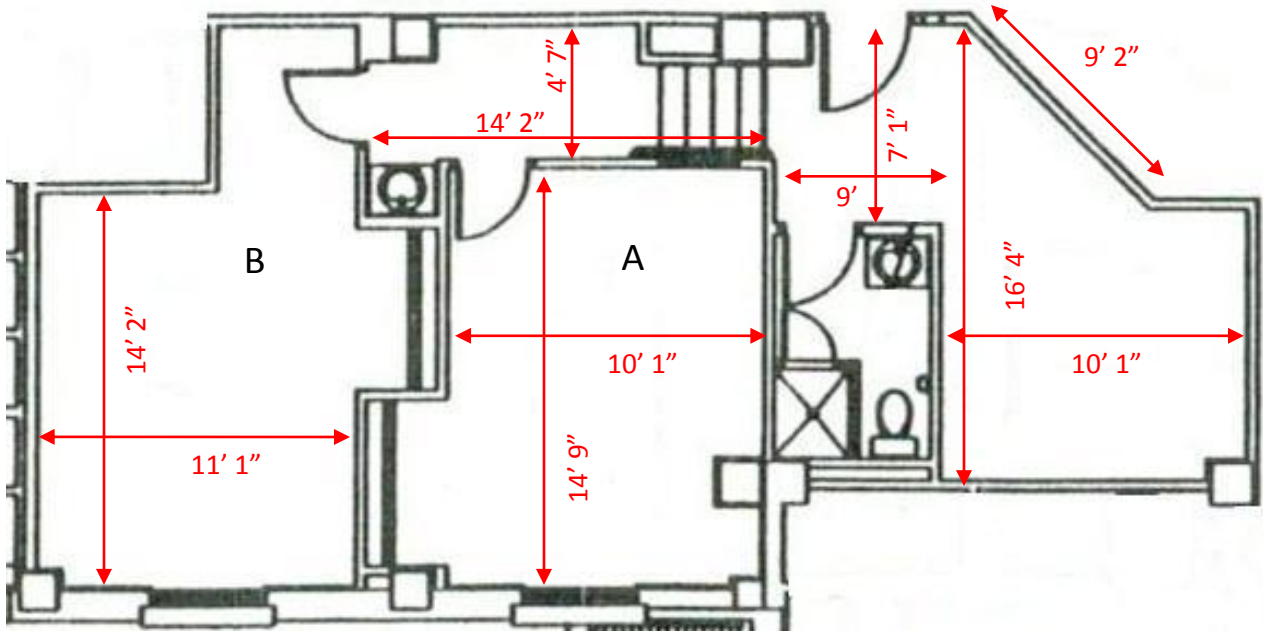

*Room floor plans may be mirror image depending on location.

*All Dimensions are approximate and may vary from room to room.

1st Floor - 45" x 73" Windows

West Bennett Floor Plan 9

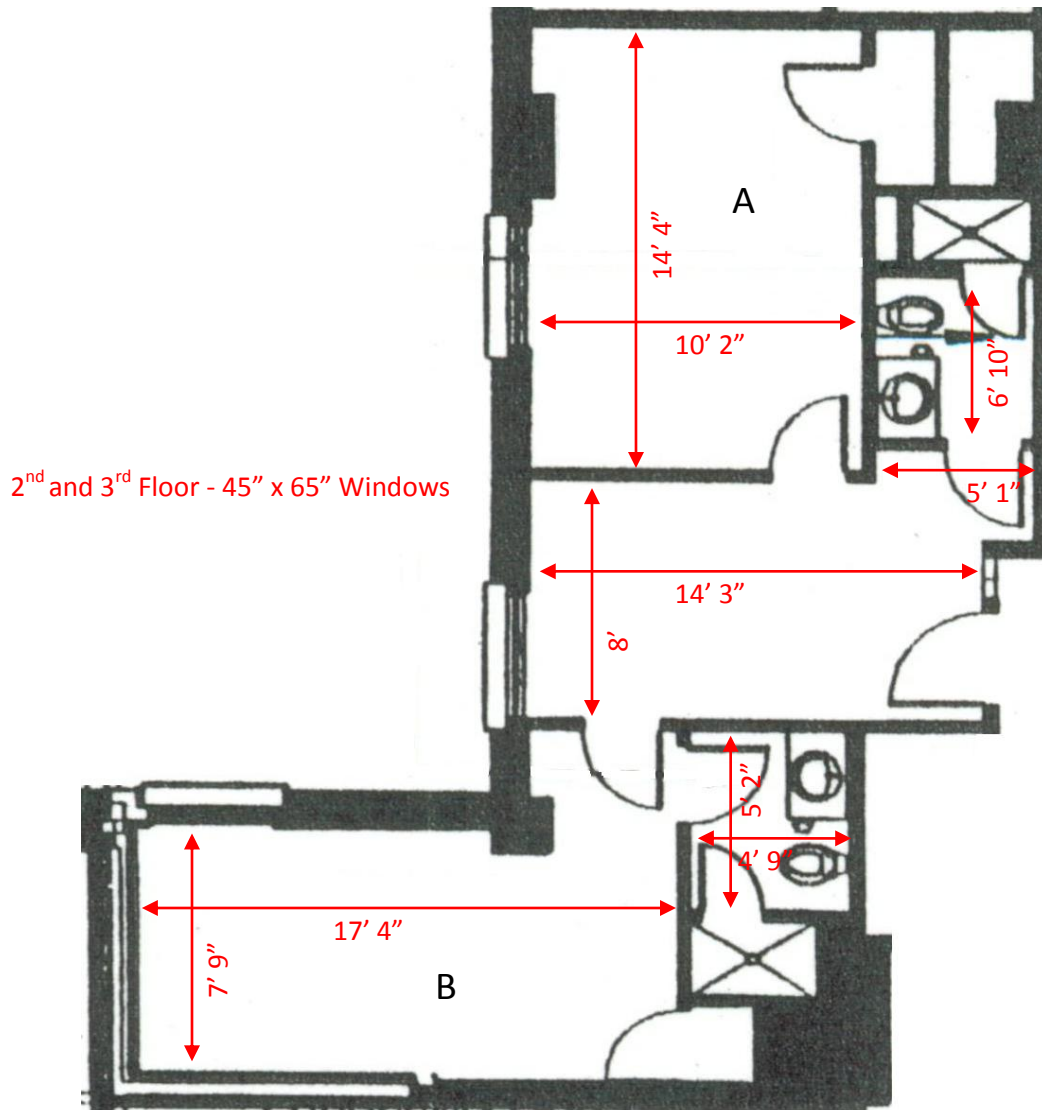

*Room floor plans may be mirror image depending on location.

*All Dimensions are approximate and may vary from room to room.

West Bennett Floor Plan 10

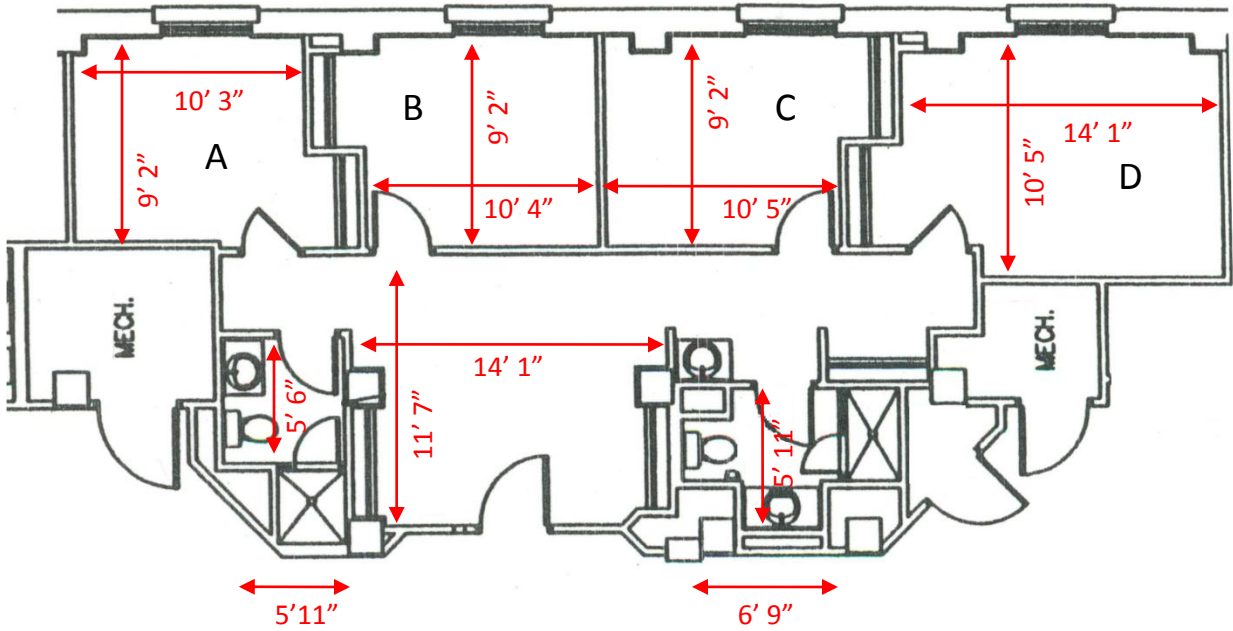

*Room floor plans may be mirror image depending on location.

*All Dimensions are approximate and may vary from room to room.

1st Floor - 45" x 73" Windows

West Bennett Floor Plan 11

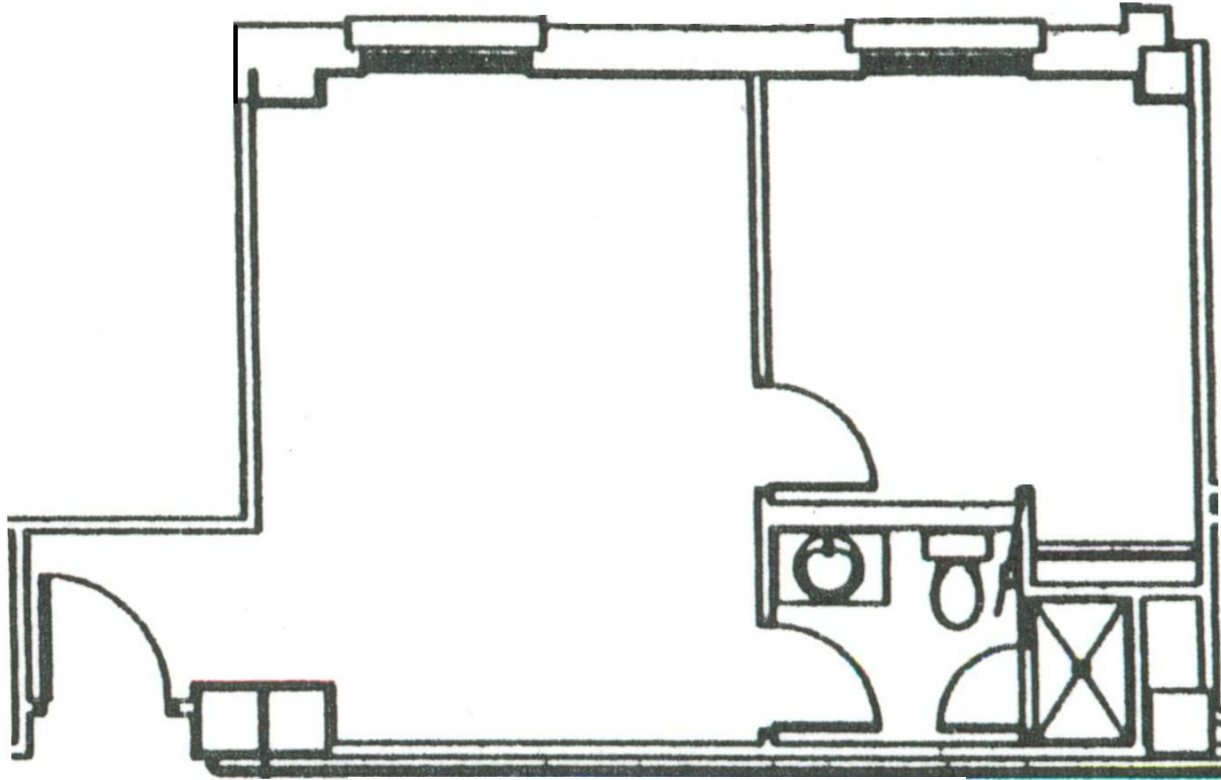

*Room floor plans may be mirror image depending on location.

*All Dimensions are approximate and may vary from room to room.

1st Floor - 45" x 73" Windows

West Bennett Floor Plan 12

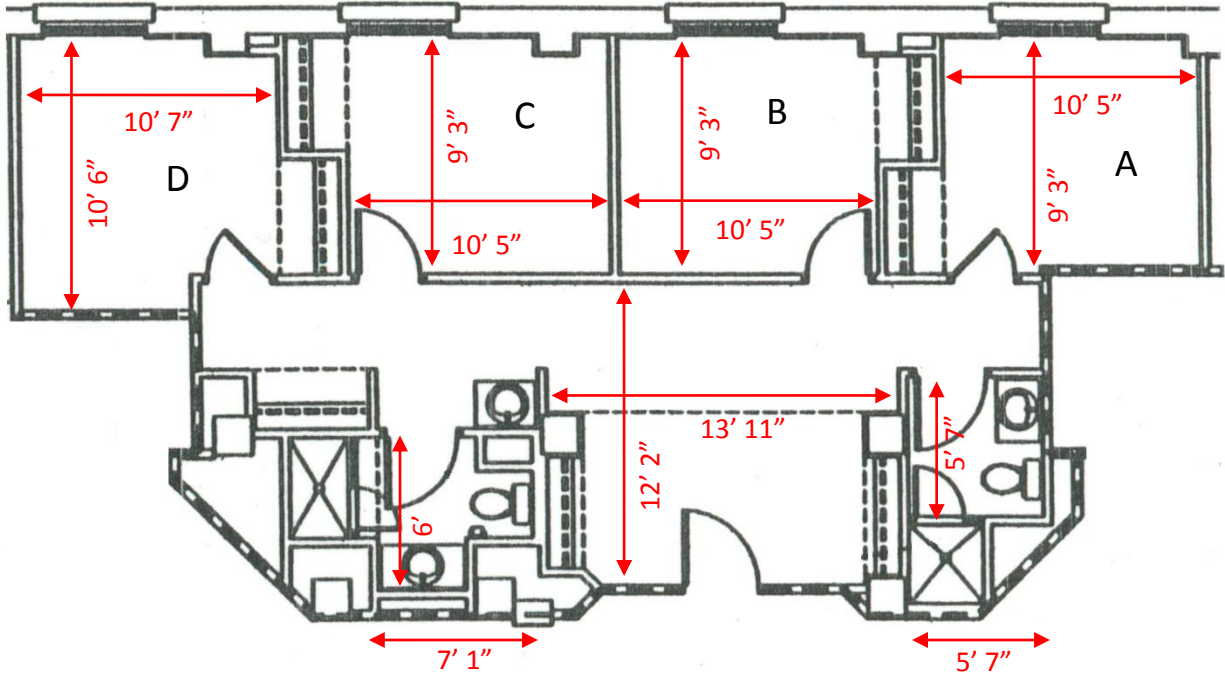

*Room floor plans may be mirror image depending on location.

*All Dimensions are approximate and may vary from room to room.

West Bennett Floor Plan 13

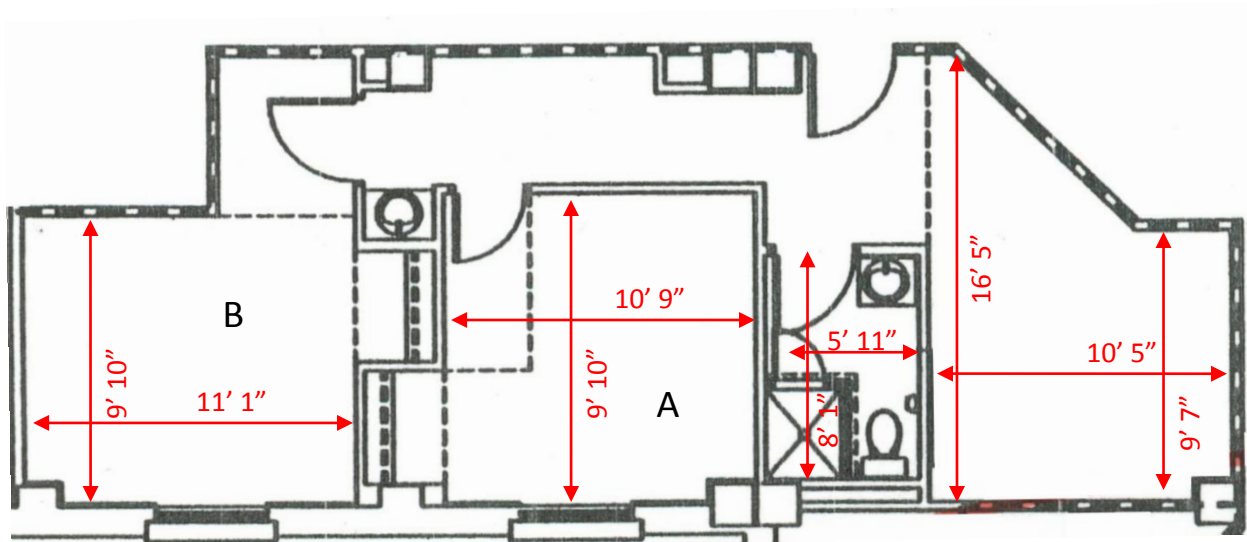

*Room floor plans may be mirror image depending on location.

*All Dimensions are approximate and may vary from room to room.

2nd and 3rd Floor - 45" x 65" Windows

West Bennett Floor Plan 14

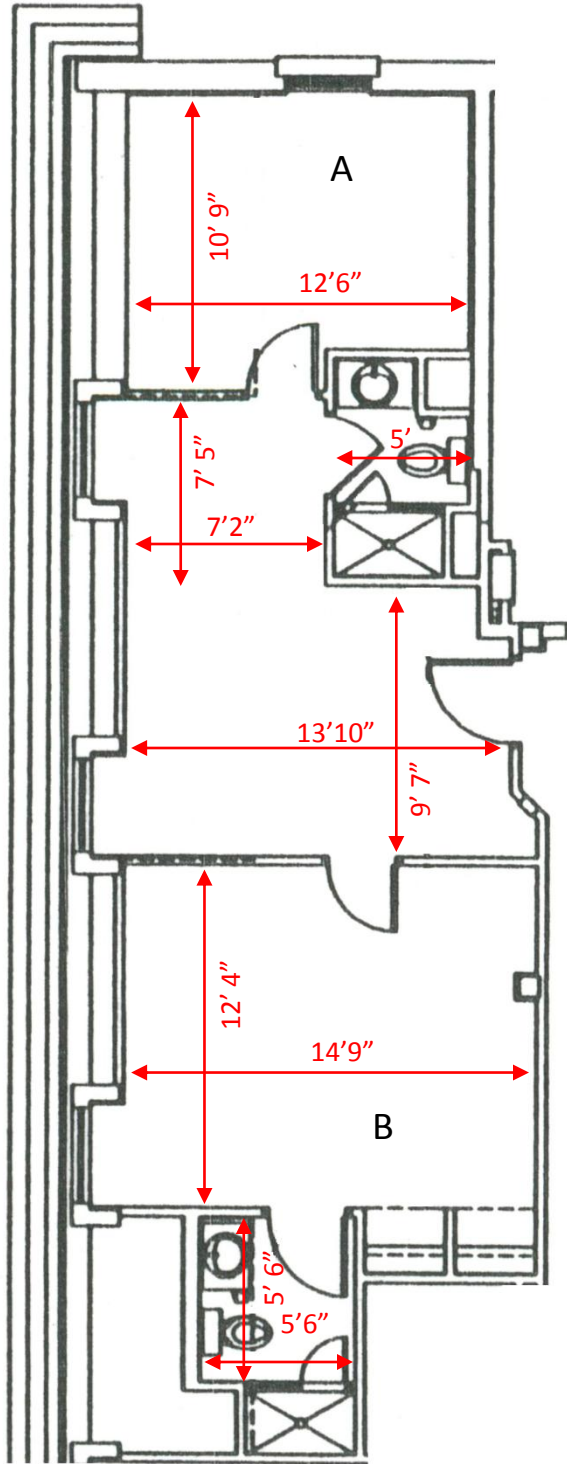

4th Floor - 38" x 56" Windows

*Room floor plans may be mirror image depending on location.

*All Dimensions are approximate and may vary from room to room.

West Bennett Floor Plan 15

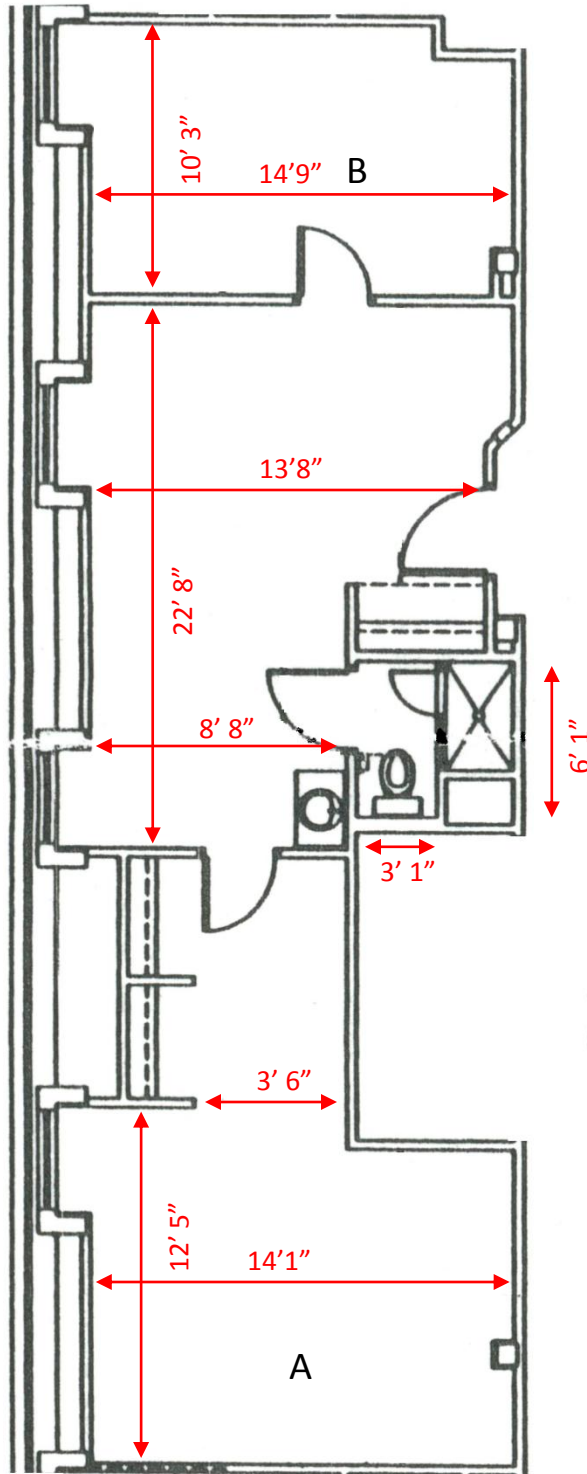

In suites 420 and 442 the "A" and "B" bedrooms are switched

4th Floor - 38" x 56" Windows

*Room floor plans may be mirror image depending on location.

*All Dimensions are approximate and may vary from room to room.

West Bennett Floor Plan 16

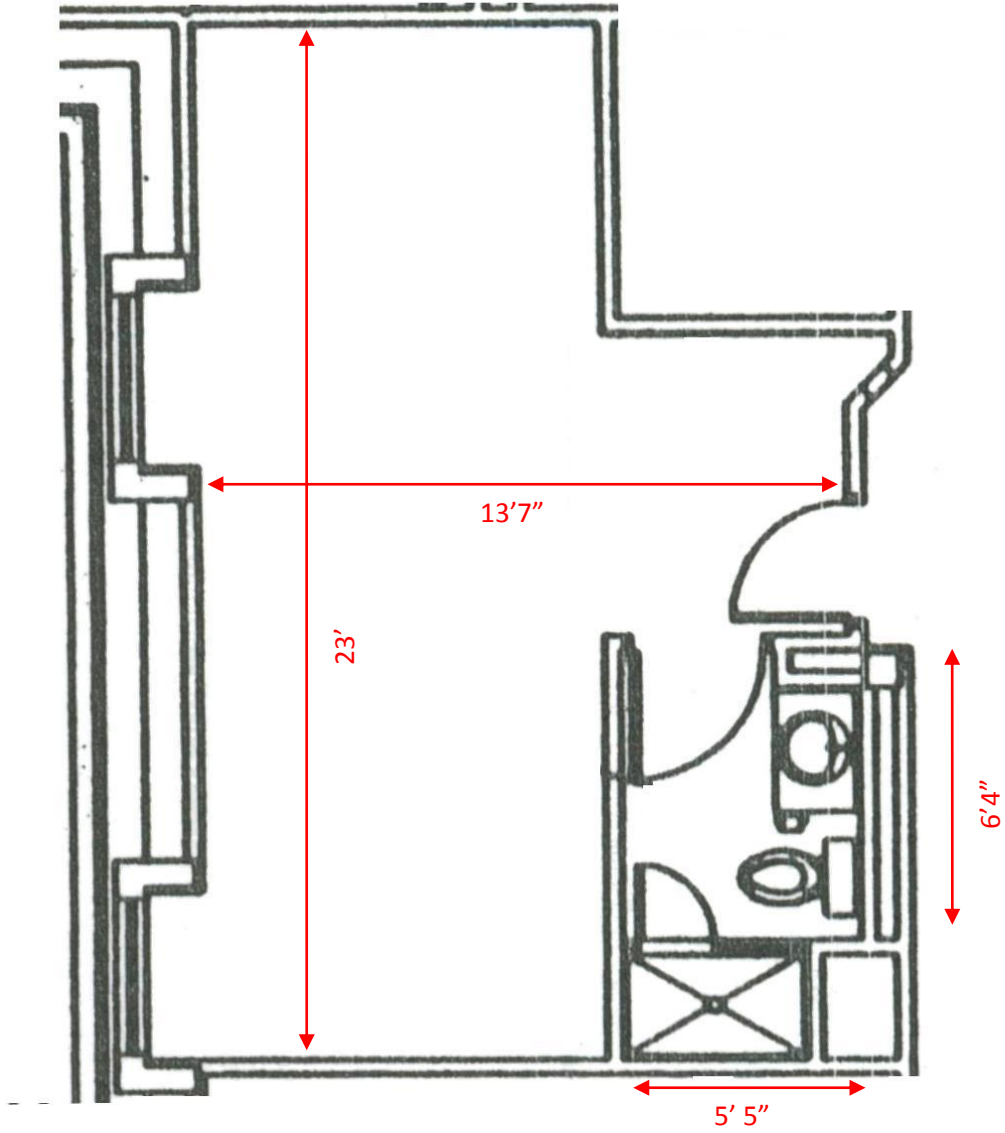

*Room floor plans may be mirror image depending on location.

*All Dimensions are approximate and may vary from room to room.

4th Floor - 38" x 56" Windows

West Bennett Floor Plan 17

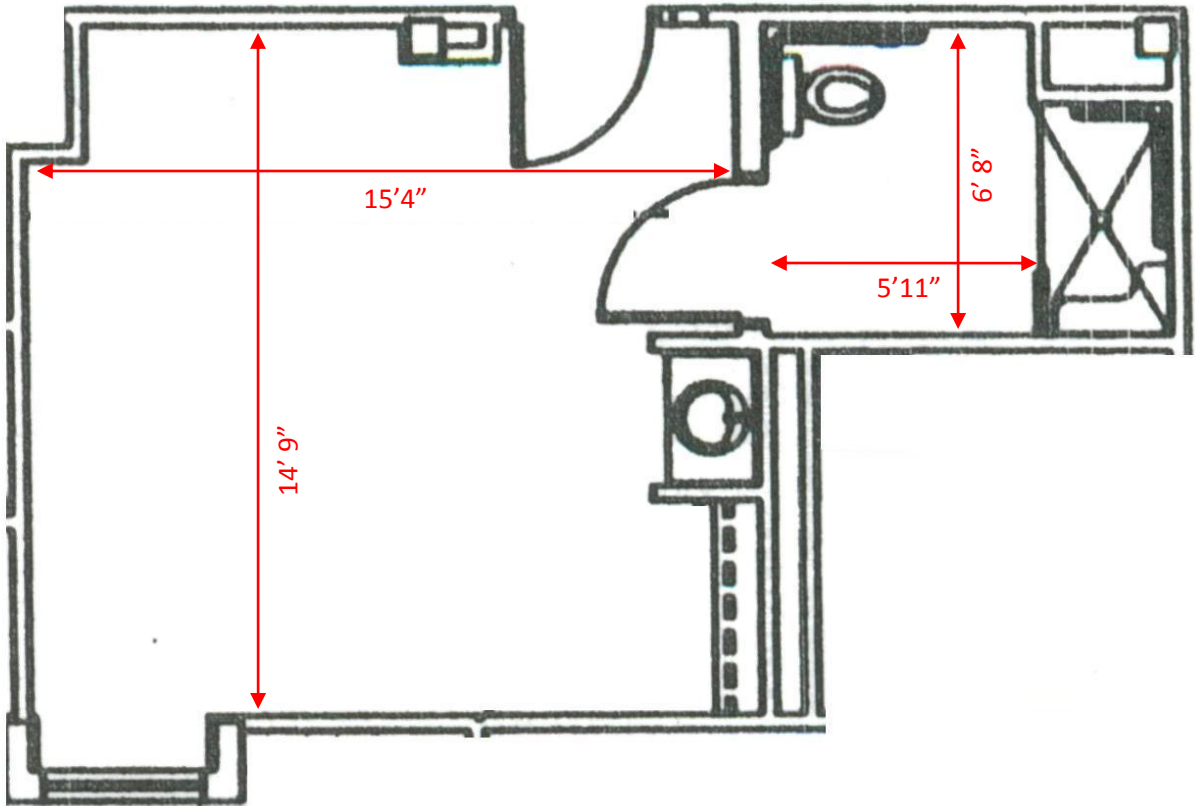

*Room floor plans may be mirror image depending on location.

*All Dimensions are approximate and may vary from room to room.

4th Floor - 38" x 56" Windows

West Bennett Floor Plan 18

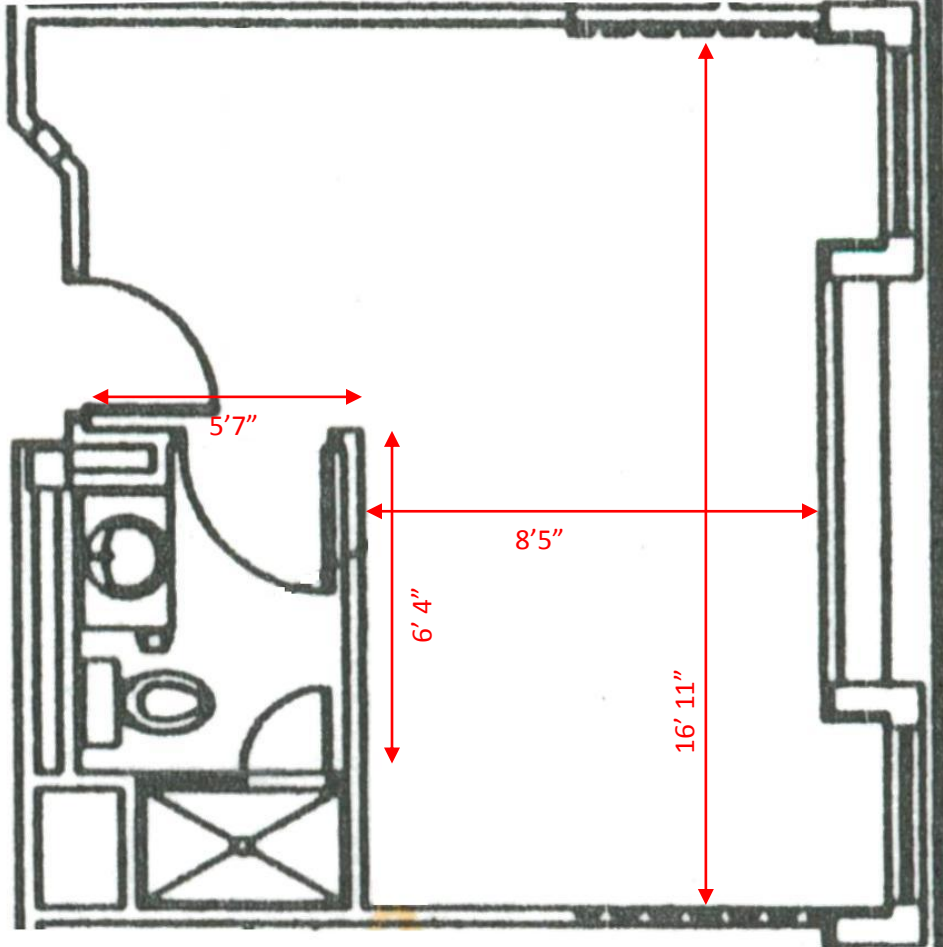

*Room floor plans may be mirror image depending on location.

*All Dimensions are approximate and may vary from room to room.

4th Floor - 38" x 56" Windows

West Bennett Floor Plan 19

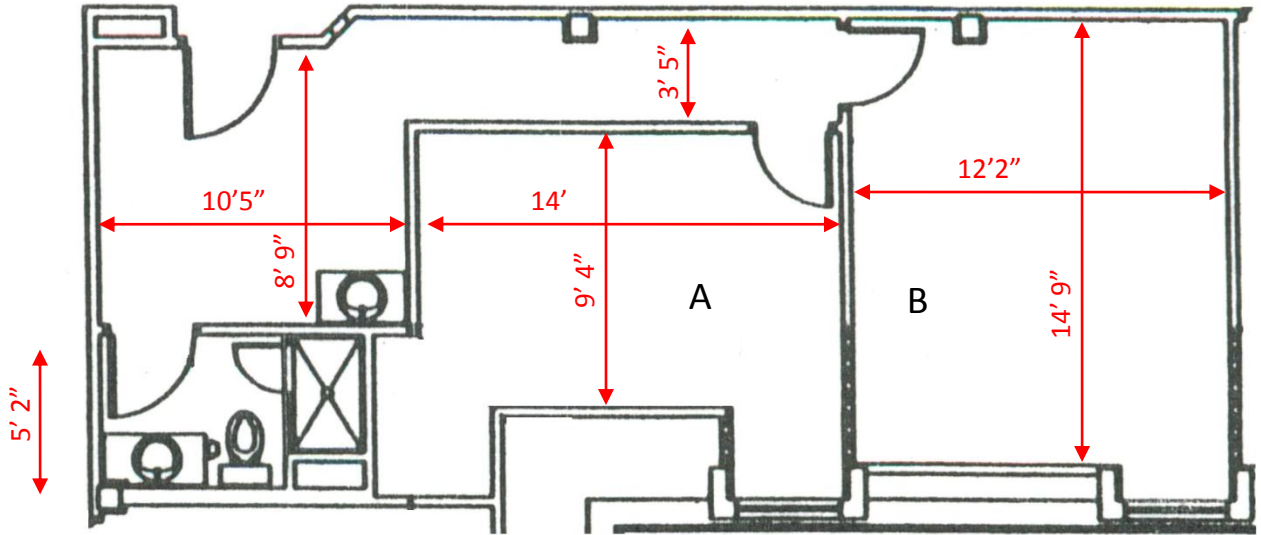

*Room floor plans may be mirror image depending on location.

*All Dimensions are approximate and may vary from room to room.

4th Floor - 38" x 56" Windows

West Bennett Floor Plan 20

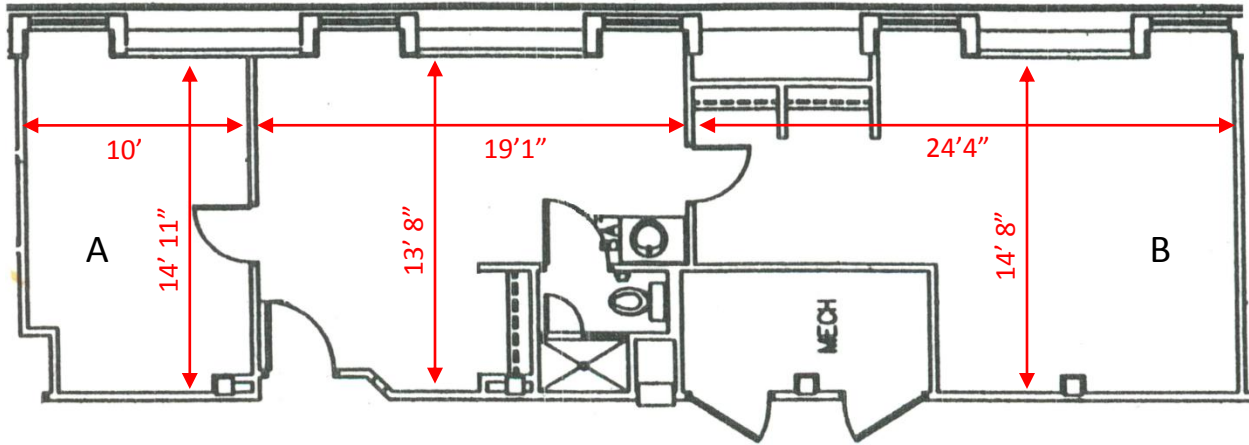

*Room floor plans may be mirror image depending on location.

*All Dimensions are approximate and may vary from room to room.

4th Floor - 38" x 56" Windows

West Bennett Floor Plan 21

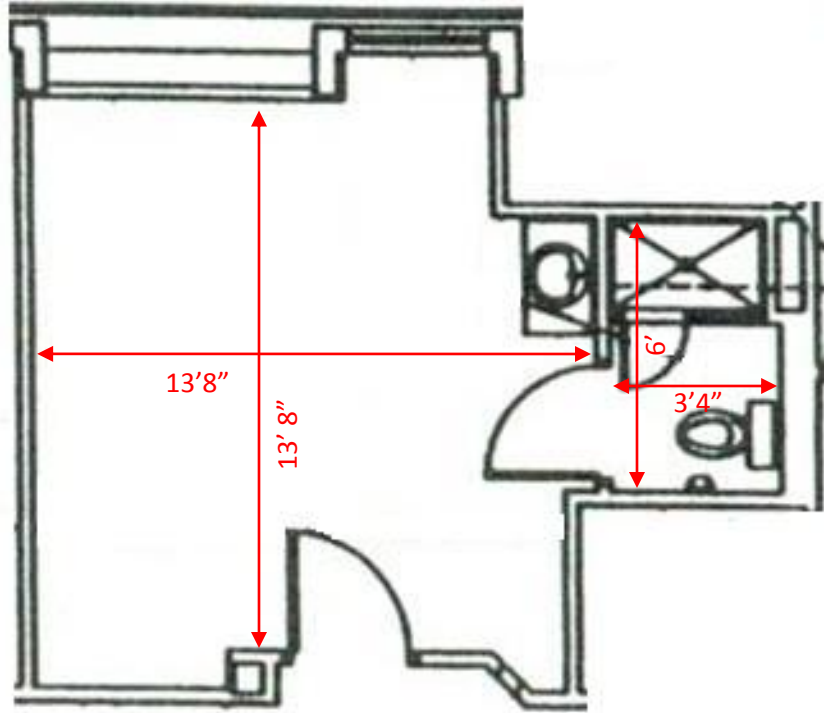

*Room floor plans may be mirror image depending on location.

*All Dimensions are approximate and may vary from room to room.

4th Floor - 38" x 56" Windows

Floor Plan Type	Room Number		
East Bennett			
<u>East Bennett 1</u>	38	151	342
	40	242	343
	139	243	353
	140	253	354
	150	254	

<u>East Bennett 2</u>	35	154	332
	44	232	339
	54	239	347
	136	247	357
	144	257	433

<u>East Bennett 3</u>	33	142	337
	42	237	345
	134	245	

<u>East Bennett 4</u>	47	250	
	147	350	

<u>East Bennett 5</u>	157		
-----------------------	-----	--	--

<u>East Bennett 6</u>	132		
-----------------------	-----	--	--

<u>East Bennett 7</u>	113	213	313
	114	214	314
	122	222	322
	123	223	323

<u>East Bennett 8</u>	118	218	318
	125	225	325

<u>East Bennett 9</u>	120	220	320
	127	227	327

<u>East Bennett 10</u>	111	211	311
------------------------	-----	-----	-----

<u>East Bennett 11</u>	116	216	316
------------------------	-----	-----	-----

<u>East Bennett 12</u>	109		
------------------------	-----	--	--

<u>East Bennett 13</u>	259	359	
<u>East Bennett 14</u>	234	334	
<u>East Bennett 15</u>	209	309	
<u>East Bennett 16</u>	231	331	
<u>East Bennett 17</u>	413	422	
	414	423	
<u>East Bennett 18</u>	411	420	425
<u>East Bennett 19</u>	443	454	
	444	455	
<u>East Bennett 20</u>	440	447	458
<u>East Bennett 21</u>	438		
<u>East Bennett 22</u>	449		
<u>East Bennett 23</u>	452		
<u>East Bennett 24</u>	460		
<u>East Bennett 25</u>	435		
<u>East Bennett 26</u>	409		
<u>East Bennett 27</u>	416		
<u>East Bennett 28</u>	418		
<u>East Bennett 29</u>	427		
<u>East Bennett 30</u>	431		

Floor Plan Type	Room Number		
Center Bennett			
<u>Center Bennett 1</u>	201	301	401
	214	314	414
	226	326	426

<u>Center Bennett 2</u>	202	302	402
	203	303	403
	204	304	404
	205	305	405
	207	307	407
	208	308	408
	209	309	409
	210	310	410
	211	311	411
	212	312	412
	215	315	415
	216	316	416
	217	317	417
	218	318	418
	219	319	419
	220	320	420
	222	322	422
	223	323	423
	224	324	424
	225	325	425

<u>Center Bennett 3</u>	206	306	406
	221	321	421

Floor Plan Type	Room Number		
West Bennett			
<u>West Bennett 1</u>	113	213	313
	114	214	314
	123	223	323
	139	239	339
	150	250	
	151	251	

<u>West Bennett 2</u>	118	218	336
	125	225	344
	136	236	
	144	244	

<u>West Bennett 3</u>	120	220	320
	127	227	327
	134	234	334
	142	242	342

<u>West Bennett 4</u>	122	222	322
	140	240	

<u>West Bennett 5</u>	154		
-----------------------	-----	--	--

<u>West Bennett 6</u>	157		
-----------------------	-----	--	--

<u>West Bennett 7</u>	116	216	316
	147	247	347

<u>West Bennett 8</u>	129	132	
-----------------------	-----	-----	--

<u>West Bennett 9</u>	209	309	
	257	357	

<u>West Bennett 10</u>	111		
------------------------	-----	--	--

<u>West Bennett 11</u>	109		
------------------------	-----	--	--

<u>West Bennett 12</u>	211	311	
	254	354	

<u>West Bennett 13</u>	229	329
	232	332

<u>West Bennett 14</u>	413	423	450
	414	439	451
	422	440	

<u>West Bennett 15</u>	420	436
	425	442

<u>West Bennett 16</u>	418	444
------------------------	-----	-----

<u>West Bennett 17</u>	416	447
------------------------	-----	-----

<u>West Bennett 18</u>	427	434
------------------------	-----	-----

<u>West Bennett 19</u>	429	432
------------------------	-----	-----

<u>West Bennett 20</u>	411	454
------------------------	-----	-----

<u>West Bennett 21</u>	409	457
------------------------	-----	-----

Booker - Stinchcomb

Room Number					
<u>101</u>	<u>132</u>	<u>218</u>	<u>303</u>	<u>332</u>	<u>417</u>
<u>102</u>	<u>133</u>	<u>219</u>	<u>304</u>	<u>333</u>	<u>418</u>
<u>103</u>	<u>134</u>	<u>220</u>	<u>305</u>	<u>334</u>	<u>419</u>
<u>104</u>	<u>136</u>	<u>221</u>	<u>306</u>	<u>335</u>	<u>420</u>
<u>105</u>	<u>137</u>	<u>222</u>	<u>307</u>	<u>336</u>	<u>421</u>
<u>106</u>	<u>138</u>	<u>223</u>	<u>308</u>	<u>337</u>	<u>422</u>
<u>107</u>	<u>139</u>	<u>224</u>	<u>309</u>	<u>338</u>	<u>423</u>
<u>108</u>	<u>140</u>	<u>225</u>	<u>310</u>	<u>339</u>	<u>424</u>
<u>109</u>	<u>141</u>	<u>226</u>	<u>311</u>	<u>340</u>	<u>425</u>
<u>110</u>	<u>142</u>	<u>227</u>	<u>312</u>	<u>341</u>	<u>426</u>
<u>111</u>	<u>143</u>	<u>228</u>	<u>313</u>	<u>342</u>	<u>427</u>
<u>112</u>	<u>144</u>	<u>229</u>	<u>314</u>	<u>343</u>	<u>428</u>
<u>113</u>	<u>201</u>	<u>230</u>	<u>315</u>	<u>344</u>	<u>429</u>
<u>114</u>	<u>202</u>	<u>231</u>	<u>316</u>	<u>401</u>	<u>430</u>
<u>115</u>	<u>203</u>	<u>232</u>	<u>317</u>	<u>402</u>	<u>431</u>
<u>116</u>	<u>204</u>	<u>233</u>	<u>318</u>	<u>403</u>	<u>432</u>
<u>117</u>	<u>205</u>	<u>234</u>	<u>319</u>	<u>404</u>	<u>433</u>
<u>118</u>	<u>206</u>	<u>235</u>	<u>320</u>	<u>405</u>	<u>434</u>
<u>119</u>	<u>207</u>	<u>236</u>	<u>321</u>	<u>406</u>	<u>435</u>
<u>120</u>	<u>208</u>	<u>237</u>	<u>322</u>	<u>407</u>	<u>436</u>
<u>121</u>	<u>209</u>	<u>238</u>	<u>323</u>	<u>408</u>	<u>437</u>
<u>122</u>	<u>210</u>	<u>239</u>	<u>324</u>	<u>409</u>	<u>438</u>
<u>123</u>	<u>211</u>	<u>240</u>	<u>325</u>	<u>410</u>	<u>439</u>
<u>124</u>	<u>212</u>	<u>241</u>	<u>326</u>	<u>411</u>	<u>440</u>
<u>126</u>	<u>213</u>	<u>242</u>	<u>327</u>	<u>412</u>	<u>441</u>
<u>128</u>	<u>214</u>	<u>243</u>	<u>328</u>	<u>413</u>	<u>442</u>
<u>129</u>	<u>215</u>	<u>244</u>	<u>329</u>	<u>414</u>	<u>443</u>
<u>130</u>	<u>216</u>	<u>301</u>	<u>330</u>	<u>415</u>	<u>444</u>
<u>131</u>	<u>217</u>	<u>302</u>	<u>331</u>	<u>416</u>	

Booker - Stinchcomb Floor Plan 1

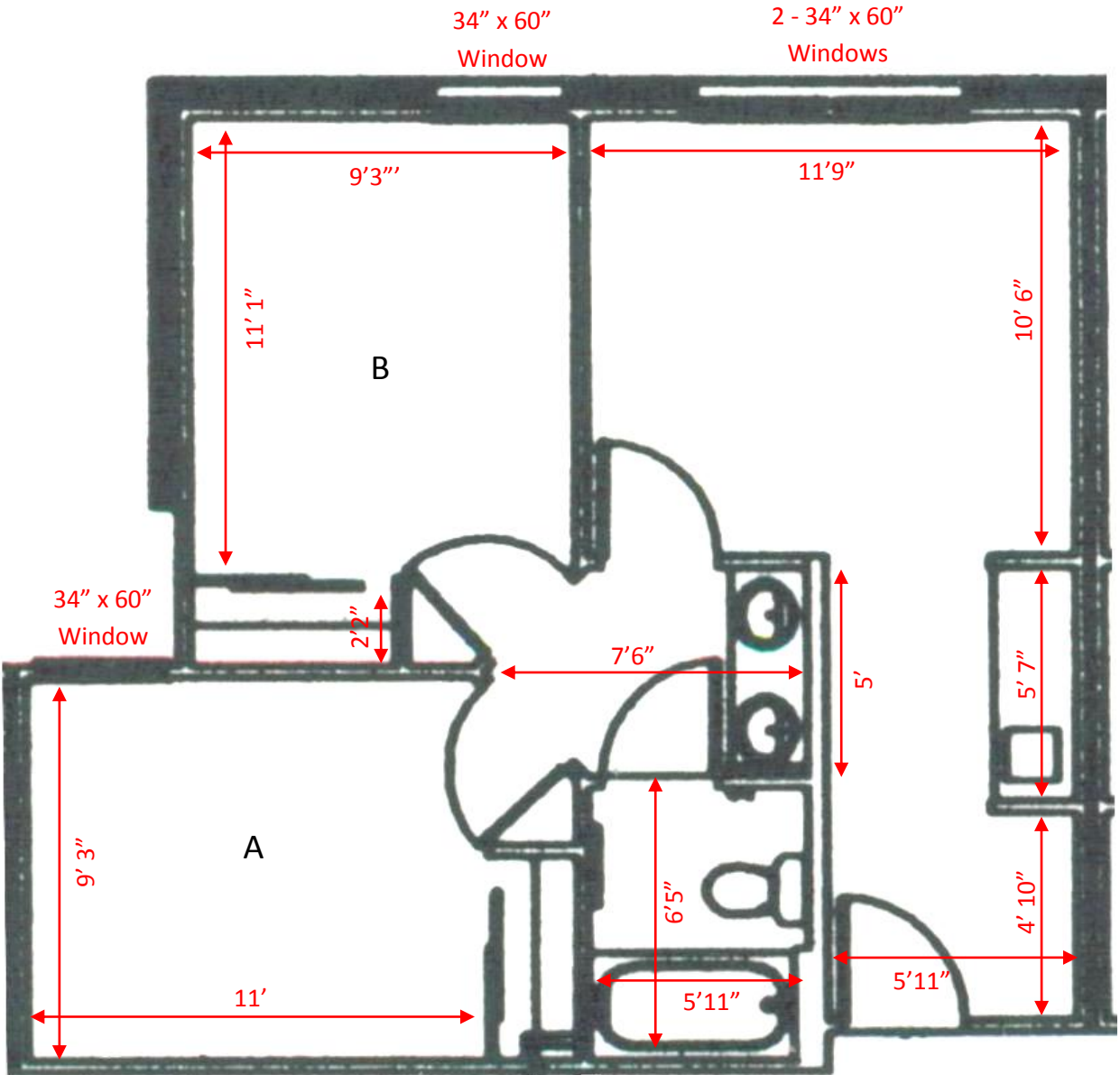

*Room floor plans may be mirror image depending on location.

*All Dimensions are approximate and may vary from room to room.

Booker - Stinchcomb Floor Plan 2

*Room floor plans may be mirror image depending on location.

*All Dimensions are approximate and may vary from room to room.

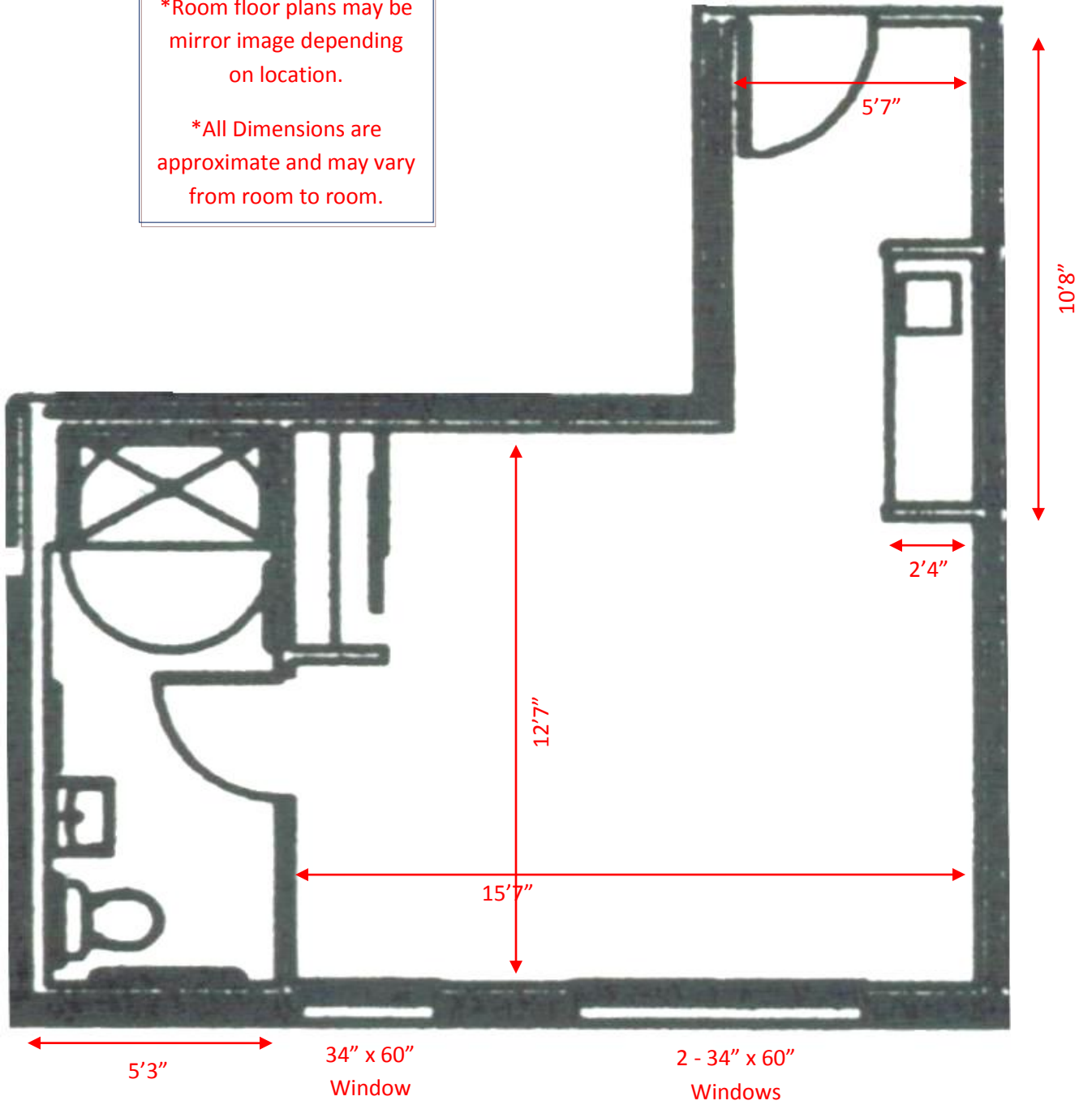

Booker - Stinchcomb Floor Plan 3

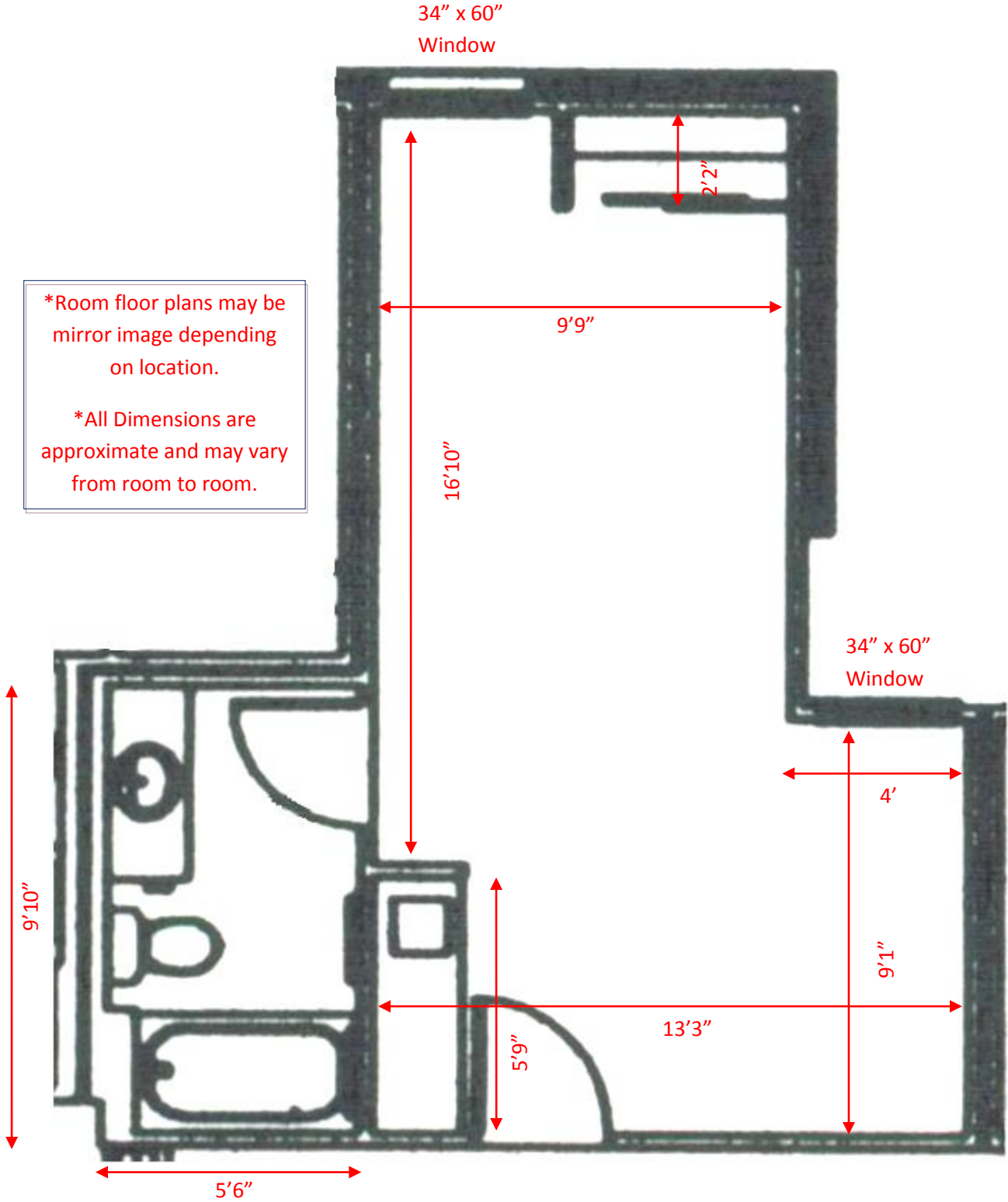

Booker - Stinchcomb Floor Plan 4

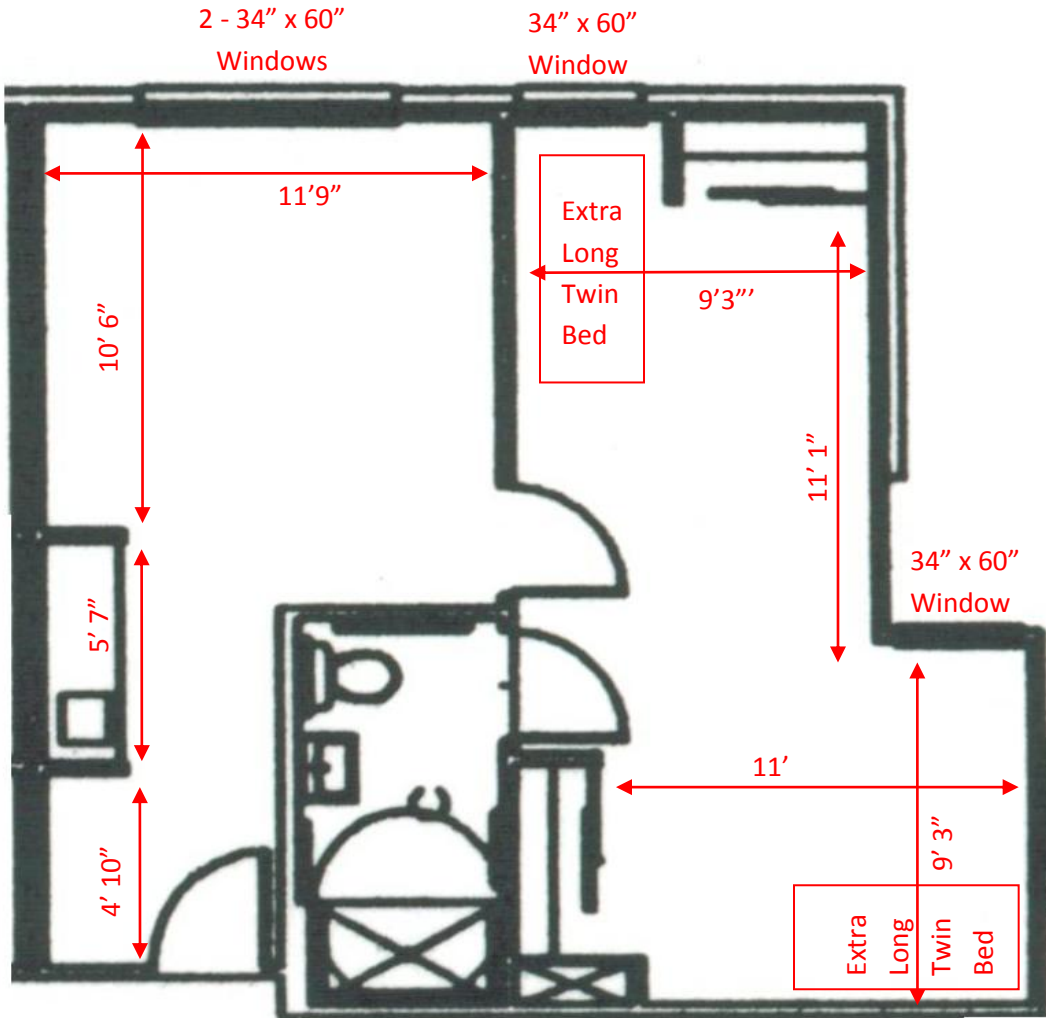

*Room floor plans may be mirror image depending on location.

*All Dimensions are approximate and may vary from room to room.

Patchin - Jones

Room Number			
<u>101</u>	<u>207</u>	<u>310</u>	<u>413</u>
<u>103</u>	<u>208</u>	<u>311</u>	<u>414</u>
<u>104</u>	<u>209</u>	<u>312</u>	<u>415</u>
<u>105</u>	<u>210</u>	<u>313</u>	<u>416</u>
<u>106</u>	<u>211</u>	<u>314</u>	<u>417</u>
<u>107</u>	<u>212</u>	<u>315</u>	<u>418</u>
<u>108</u>	<u>213</u>	<u>316</u>	<u>419</u>
<u>109</u>	<u>214</u>	<u>317</u>	<u>420</u>
<u>110</u>	<u>215</u>	<u>318</u>	<u>421</u>
<u>111</u>	<u>216</u>	<u>319</u>	<u>422</u>
<u>112</u>	<u>217</u>	<u>320</u>	
<u>113</u>	<u>218</u>	<u>321</u>	
<u>114</u>	<u>219</u>	<u>322</u>	
<u>116</u>	<u>220</u>	<u>401</u>	
<u>117</u>	<u>221</u>	<u>402</u>	
<u>118</u>	<u>222</u>	<u>403</u>	
<u>119</u>	<u>301</u>	<u>404</u>	
<u>120</u>	<u>302</u>	<u>405</u>	
<u>122</u>	<u>303</u>	<u>406</u>	
<u>201</u>	<u>304</u>	<u>407</u>	
<u>202</u>	<u>305</u>	<u>408</u>	
<u>203</u>	<u>306</u>	<u>409</u>	
<u>204</u>	<u>307</u>	<u>410</u>	
<u>205</u>	<u>308</u>	<u>411</u>	
<u>206</u>	<u>309</u>	<u>412</u>	

Patchin-Jones Floor Plan 1

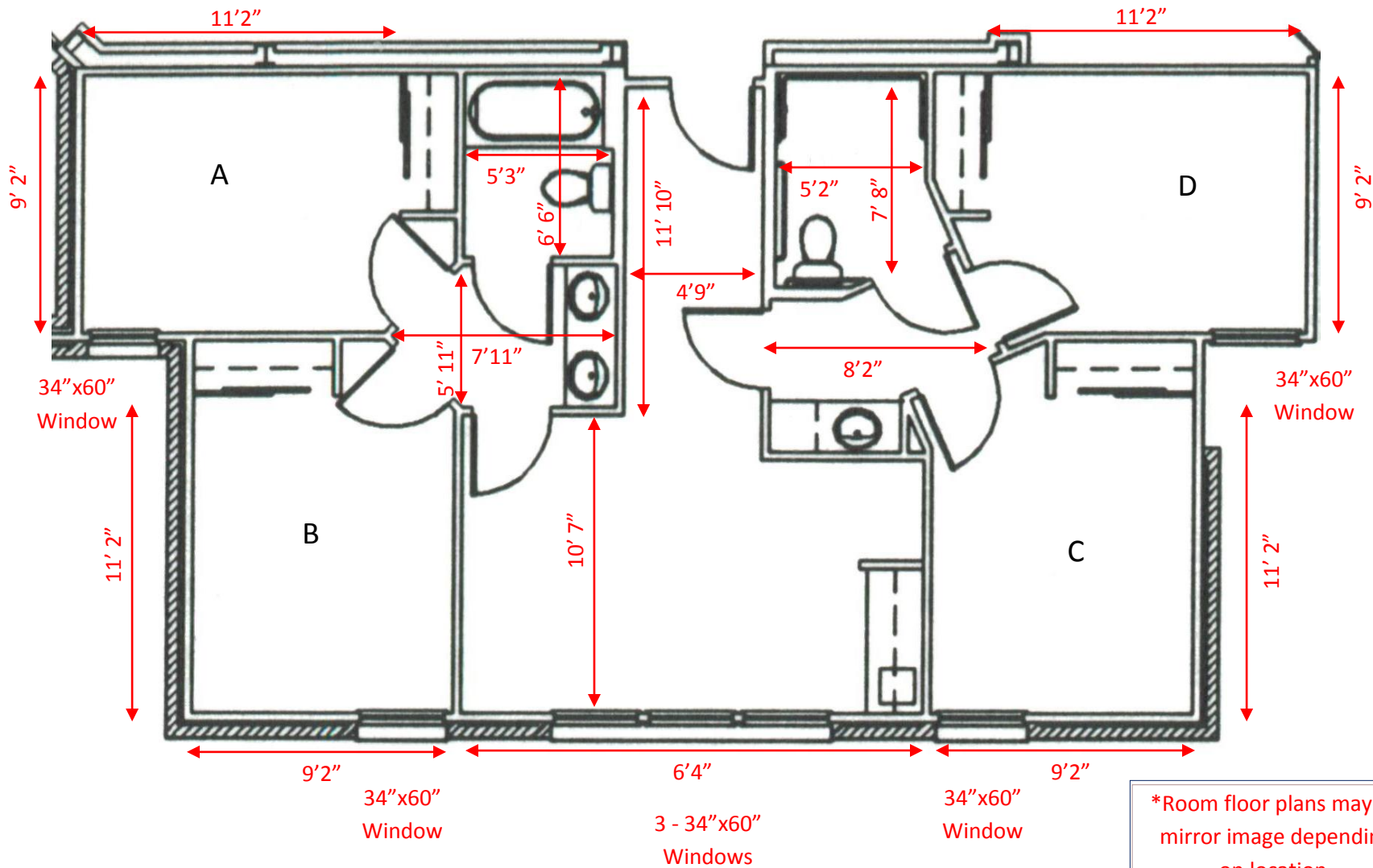

*Room floor plans may be mirror image depending on location.

*All Dimensions are approximate and may vary from room to room.

Patchin-Jones Floor Plan 2

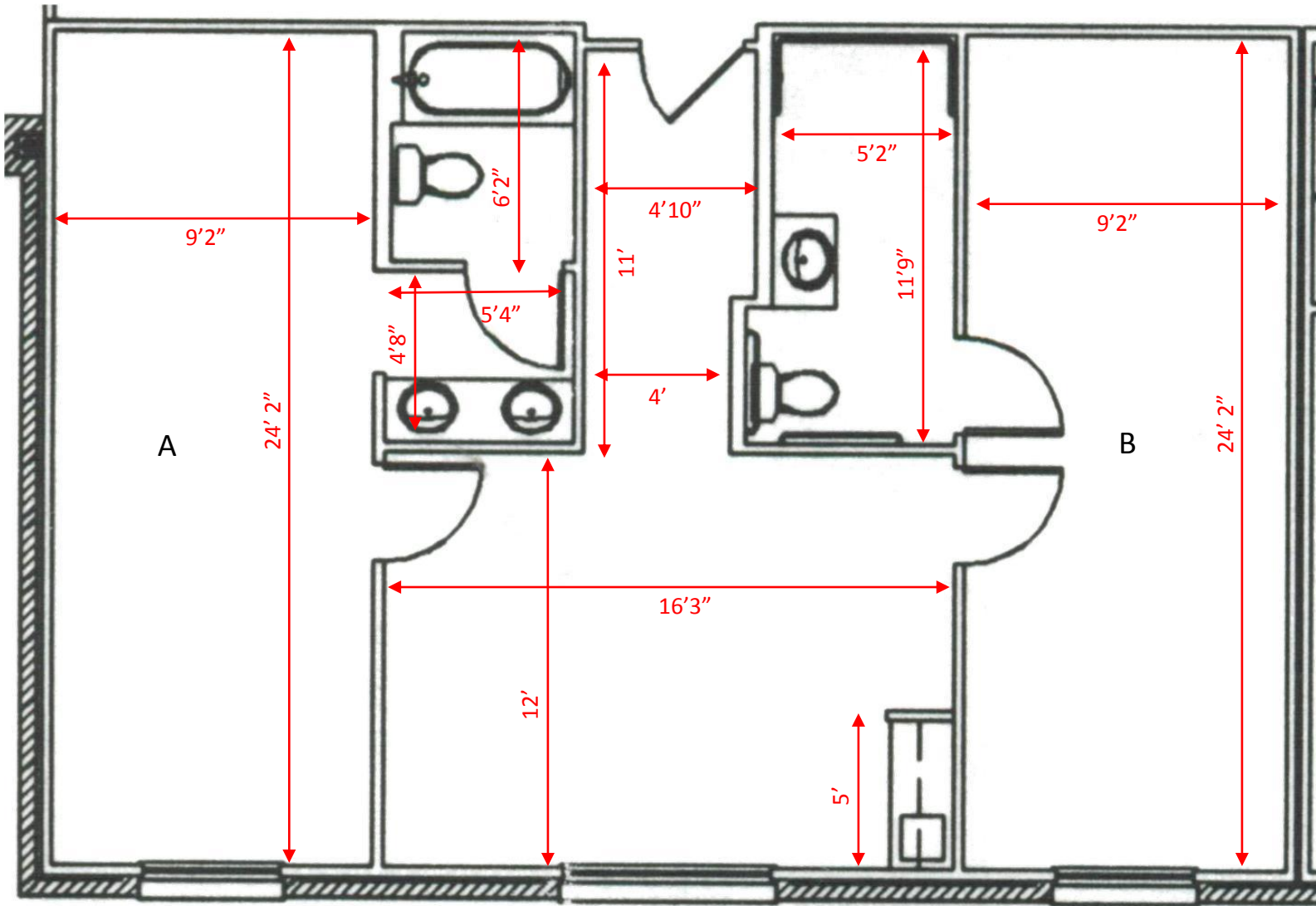

46"x46"
Window

70"x58"
Window

46"x46"
Window

*Room floor plans may be mirror image depending on location.

*All Dimensions are approximate and may vary from room to room.

Patchin-Jones Floor Plan 3

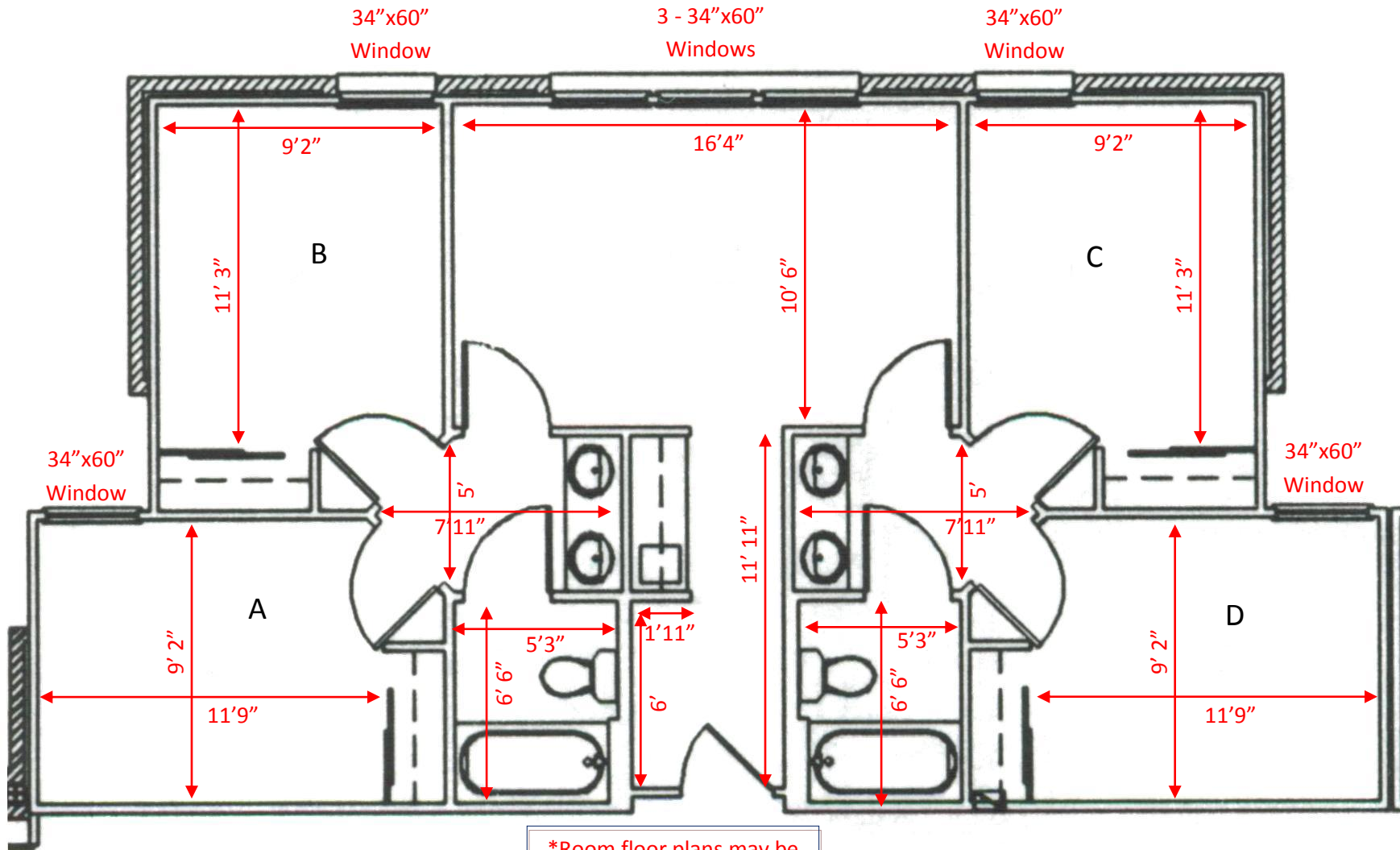

*Room floor plans may be mirror image depending on location.

*All Dimensions are approximate and may vary from room to room.

Patchin-Jones Floor Plan 4

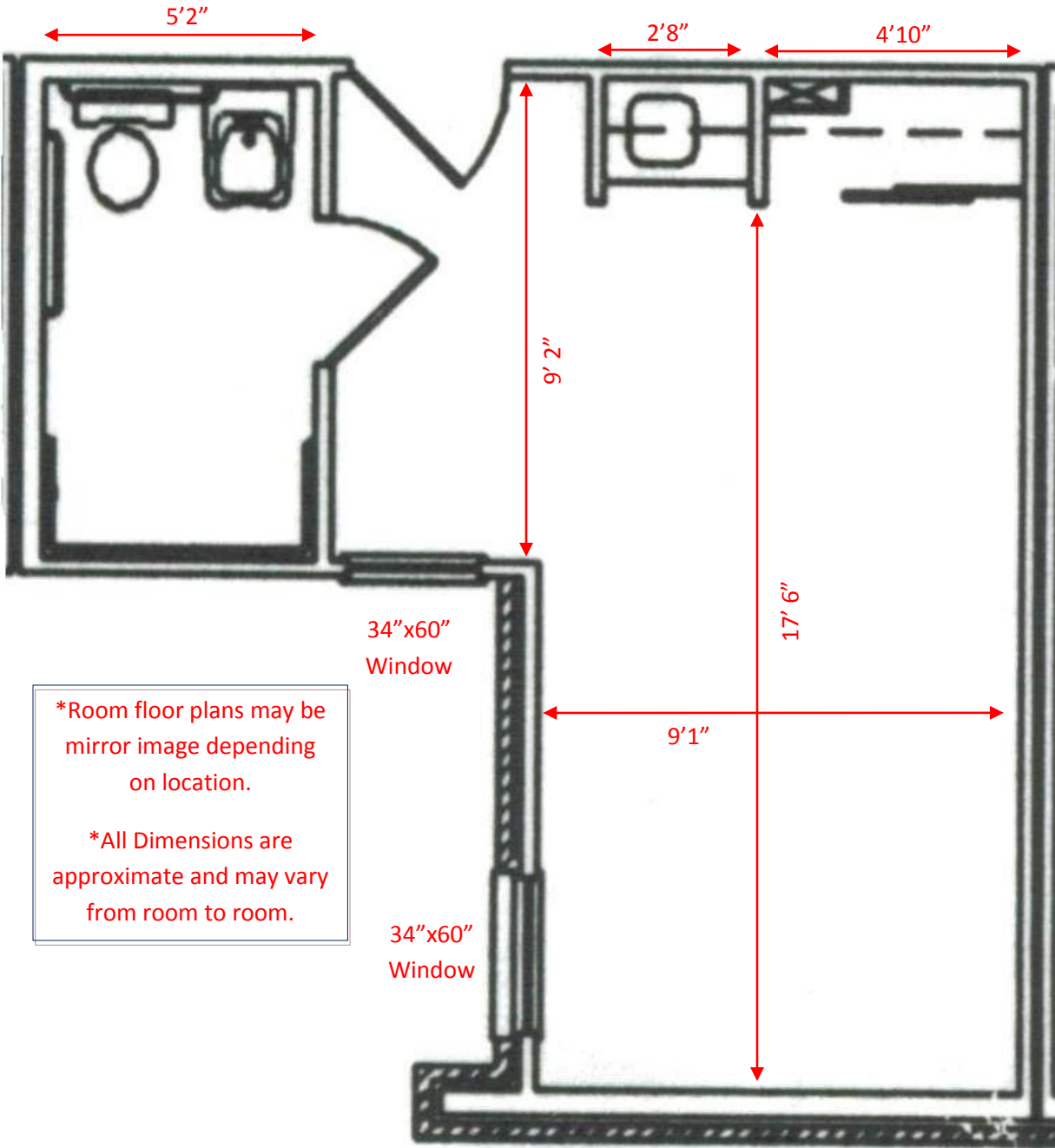

*Room floor plans may be mirror image depending on location.

*All Dimensions are approximate and may vary from room to room.

Patchin-Jones Floor Plan 5

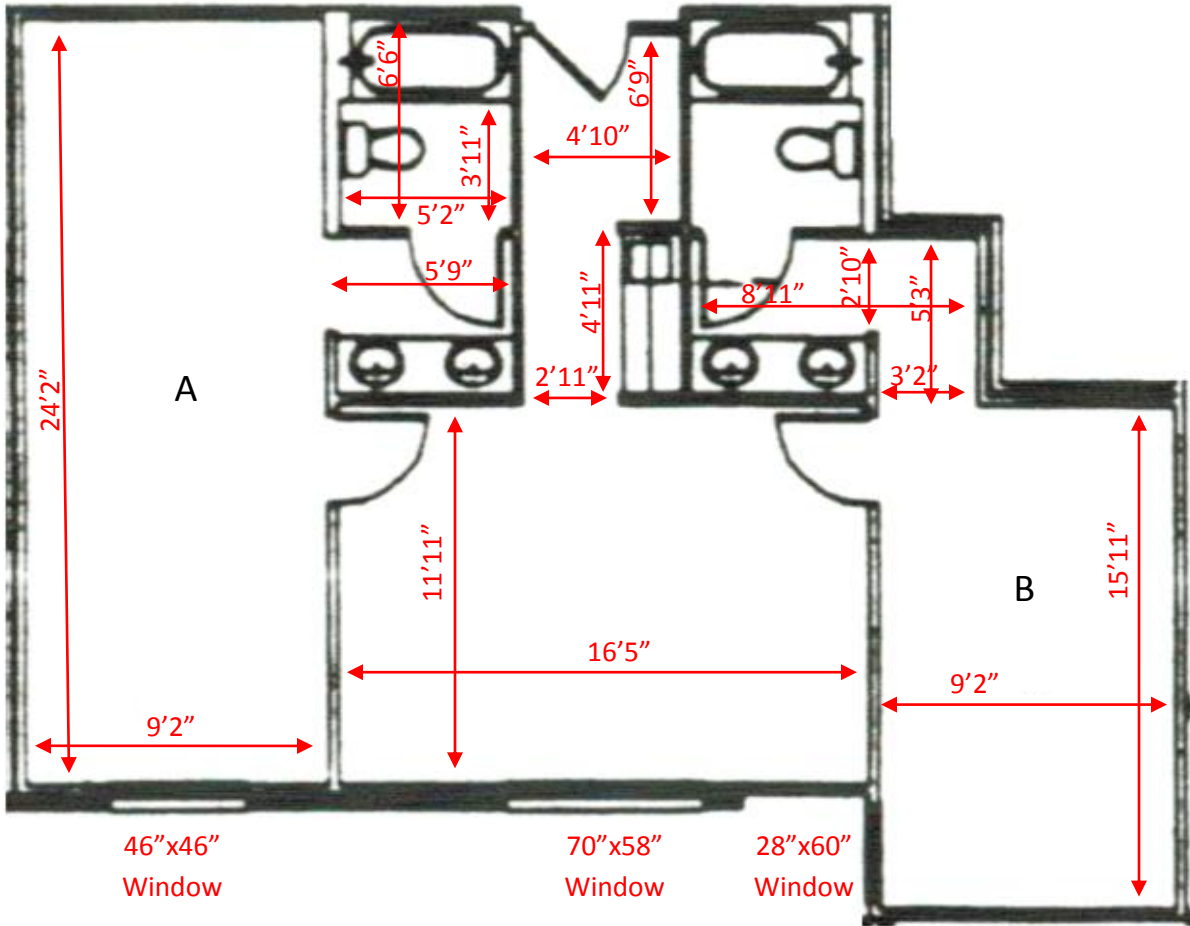

*Room floor plans may be mirror image depending on location.

*All Dimensions are approximate and may vary from room to room.

Patchin-Jones Floor Plan 6

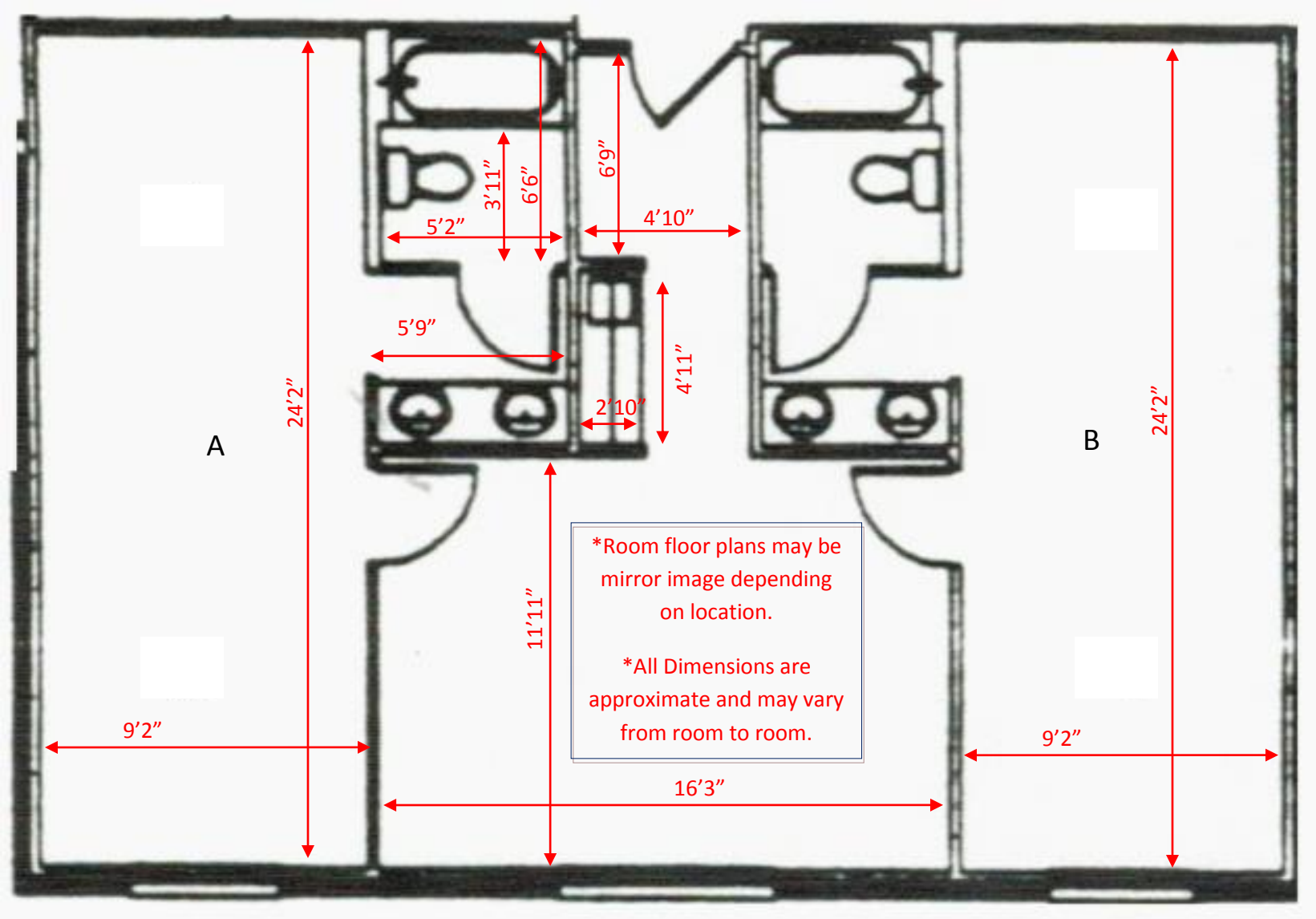

46"x46"
Window

70"x58"
Window

46"x46"
Window

Patchin - Jones Floor Plan 7

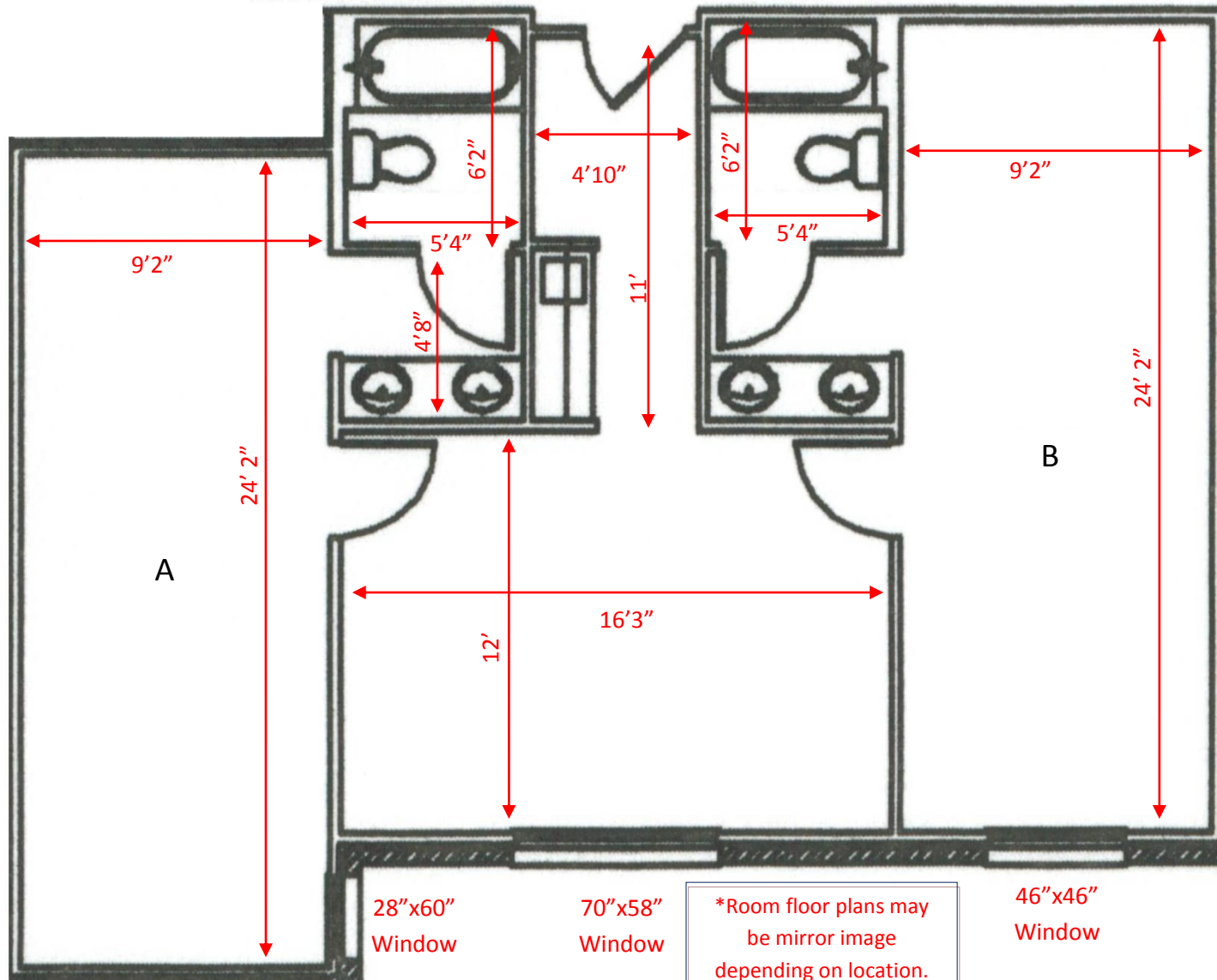

*Room floor plans may be mirror image depending on location.

*All Dimensions are approximate and may vary from room to room.

Village C&D

Room Number

<u>101</u>	<u>147</u>	<u>203</u>	<u>241</u>	<u>281</u>	<u>329</u>	<u>369</u>	<u>421</u>	<u>461</u>
<u>102</u>	<u>148</u>	<u>204</u>	<u>242</u>	<u>282</u>	<u>330</u>	<u>370</u>	<u>422</u>	<u>462</u>
<u>103</u>	<u>149</u>	<u>205</u>	<u>245</u>	<u>283</u>	<u>331</u>	<u>371</u>	<u>423</u>	<u>463</u>
<u>104</u>	<u>150</u>	<u>206</u>	<u>246</u>	<u>284</u>	<u>335</u>	<u>372</u>	<u>424</u>	<u>464</u>
<u>105</u>	<u>152</u>	<u>208</u>	<u>247</u>	<u>285</u>	<u>337</u>	<u>373</u>	<u>425</u>	<u>465</u>
<u>106</u>	<u>156</u>	<u>212</u>	<u>248</u>	<u>286</u>	<u>338</u>	<u>374</u>	<u>426</u>	<u>466</u>
<u>108</u>	<u>157</u>	<u>213</u>	<u>249</u>	<u>301</u>	<u>339</u>	<u>375</u>	<u>427</u>	<u>467</u>
<u>112</u>	<u>158</u>	<u>214</u>	<u>250</u>	<u>302</u>	<u>340</u>	<u>379</u>	<u>428</u>	<u>468</u>
<u>113</u>	<u>159</u>	<u>215</u>	<u>252</u>	<u>303</u>	<u>341</u>	<u>381</u>	<u>429</u>	<u>469</u>
<u>114</u>	<u>160</u>	<u>216</u>	<u>256</u>	<u>304</u>	<u>342</u>	<u>382</u>	<u>430</u>	<u>470</u>
<u>115</u>	<u>161</u>	<u>217</u>	<u>257</u>	<u>305</u>	<u>345</u>	<u>383</u>	<u>431</u>	<u>471</u>
<u>116</u>	<u>162</u>	<u>218</u>	<u>258</u>	<u>306</u>	<u>346</u>	<u>384</u>	<u>435</u>	<u>472</u>
<u>117</u>	<u>163</u>	<u>219</u>	<u>259</u>	<u>308</u>	<u>347</u>	<u>385</u>	<u>437</u>	<u>473</u>
<u>118</u>	<u>164</u>	<u>220</u>	<u>260</u>	<u>312</u>	<u>348</u>	<u>386</u>	<u>438</u>	<u>474</u>
<u>119</u>	<u>165</u>	<u>221</u>	<u>261</u>	<u>313</u>	<u>349</u>	<u>401</u>	<u>439</u>	<u>475</u>
<u>120</u>	<u>166</u>	<u>222</u>	<u>262</u>	<u>314</u>	<u>350</u>	<u>402</u>	<u>440</u>	<u>479</u>
<u>121</u>	<u>167</u>	<u>223</u>	<u>263</u>	<u>315</u>	<u>352</u>	<u>403</u>	<u>441</u>	<u>481</u>
<u>122</u>	<u>168</u>	<u>224</u>	<u>264</u>	<u>316</u>	<u>356</u>	<u>404</u>	<u>442</u>	<u>482</u>
<u>127</u>	<u>169</u>	<u>225</u>	<u>265</u>	<u>317</u>	<u>357</u>	<u>405</u>	<u>445</u>	<u>483</u>
<u>128</u>	<u>171</u>	<u>226</u>	<u>266</u>	<u>318</u>	<u>358</u>	<u>406</u>	<u>446</u>	<u>484</u>
<u>129</u>	<u>175</u>	<u>227</u>	<u>267</u>	<u>319</u>	<u>359</u>	<u>408</u>	<u>447</u>	<u>485</u>
<u>130</u>	<u>179</u>	<u>228</u>	<u>268</u>	<u>320</u>	<u>360</u>	<u>412</u>	<u>448</u>	<u>486</u>
<u>131</u>	<u>181</u>	<u>229</u>	<u>269</u>	<u>321</u>	<u>361</u>	<u>413</u>	<u>449</u>	
<u>135</u>	<u>182</u>	<u>230</u>	<u>270</u>	<u>322</u>	<u>362</u>	<u>414</u>	<u>450</u>	
<u>137</u>	<u>183</u>	<u>231</u>	<u>271</u>	<u>323</u>	<u>363</u>	<u>415</u>	<u>452</u>	
<u>138</u>	<u>184</u>	<u>235</u>	<u>272</u>	<u>324</u>	<u>364</u>	<u>416</u>	<u>456</u>	
<u>139</u>	<u>185</u>	<u>237</u>	<u>273</u>	<u>325</u>	<u>365</u>	<u>417</u>	<u>457</u>	
<u>140</u>	<u>186</u>	<u>238</u>	<u>274</u>	<u>326</u>	<u>366</u>	<u>418</u>	<u>458</u>	
<u>141</u>	<u>201</u>	<u>239</u>	<u>275</u>	<u>327</u>	<u>367</u>	<u>419</u>	<u>459</u>	
<u>146</u>	<u>202</u>	<u>240</u>	<u>279</u>	<u>328</u>	<u>368</u>	<u>420</u>	<u>460</u>	

Village CASNR		
Room Number		
<u>105</u>	<u>223</u>	<u>405</u>
<u>107</u>	<u>224</u>	<u>407</u>
<u>108</u>	<u>226</u>	<u>408</u>
<u>109</u>	<u>227</u>	<u>409</u>
<u>111</u>	<u>228</u>	<u>411</u>
<u>112</u>	<u>230</u>	<u>412</u>
<u>114</u>	<u>231</u>	<u>414</u>
<u>115</u>	<u>233</u>	<u>415</u>
<u>120</u>	<u>302</u>	<u>420</u>
<u>121</u>	<u>303</u>	<u>421</u>
<u>123</u>	<u>305</u>	<u>423</u>
<u>124</u>	<u>307</u>	<u>424</u>
<u>126</u>	<u>308</u>	<u>426</u>
<u>127</u>	<u>309</u>	<u>427</u>
<u>128</u>	<u>311</u>	<u>428</u>
<u>130</u>	<u>312</u>	<u>430</u>
<u>131</u>	<u>314</u>	<u>431</u>
<u>133</u>	<u>315</u>	<u>433</u>
<u>202</u>	<u>320</u>	
<u>203</u>	<u>321</u>	
<u>205</u>	<u>323</u>	
<u>207</u>	<u>324</u>	
<u>208</u>	<u>326</u>	
<u>209</u>	<u>327</u>	
<u>211</u>	<u>328</u>	
<u>212</u>	<u>330</u>	
<u>214</u>	<u>331</u>	
<u>215</u>	<u>333</u>	
<u>220</u>	<u>402</u>	
<u>221</u>	<u>403</u>	

Village HES		
Room Number		
<u>105</u>	<u>227</u>	<u>409</u>
<u>107</u>	<u>228</u>	<u>411</u>
<u>108</u>	<u>230</u>	<u>412</u>
<u>109</u>	<u>231</u>	<u>414</u>
<u>111</u>	<u>233</u>	<u>415</u>
<u>112</u>	<u>302</u>	<u>420</u>
<u>114</u>	<u>303</u>	<u>421</u>
<u>115</u>	<u>304</u>	<u>423</u>
<u>120</u>	<u>307</u>	<u>424</u>
<u>121</u>	<u>308</u>	<u>426</u>
<u>123</u>	<u>309</u>	<u>427</u>
<u>124</u>	<u>311</u>	<u>428</u>
<u>126</u>	<u>312</u>	<u>430</u>
<u>127</u>	<u>314</u>	<u>431</u>
<u>133</u>	<u>315</u>	<u>433</u>
<u>202</u>	<u>320</u>	
<u>203</u>	<u>321</u>	
<u>204</u>	<u>323</u>	
<u>207</u>	<u>324</u>	
<u>208</u>	<u>326</u>	
<u>209</u>	<u>327</u>	
<u>211</u>	<u>328</u>	
<u>212</u>	<u>330</u>	
<u>214</u>	<u>331</u>	
<u>215</u>	<u>333</u>	
<u>220</u>	<u>402</u>	
<u>221</u>	<u>403</u>	
<u>223</u>	<u>404</u>	
<u>224</u>	<u>407</u>	
<u>226</u>	<u>408</u>	

Village E&F

Room Number

<u>102</u>	<u>146</u>	<u>203</u>	<u>241</u>	<u>281</u>	<u>330</u>	<u>369</u>	<u>421</u>	<u>461</u>
<u>103</u>	<u>147</u>	<u>204</u>	<u>242</u>	<u>282</u>	<u>331</u>	<u>370</u>	<u>422</u>	<u>462</u>
<u>104</u>	<u>148</u>	<u>205</u>	<u>245</u>	<u>283</u>	<u>335</u>	<u>371</u>	<u>423</u>	<u>463</u>
<u>105</u>	<u>149</u>	<u>206</u>	<u>246</u>	<u>284</u>	<u>335</u>	<u>372</u>	<u>425</u>	<u>464</u>
<u>106</u>	<u>150</u>	<u>208</u>	<u>247</u>	<u>285</u>	<u>337</u>	<u>373</u>	<u>427</u>	<u>465</u>
<u>108</u>	<u>152</u>	<u>212</u>	<u>248</u>	<u>286</u>	<u>338</u>	<u>374</u>	<u>428</u>	<u>466</u>
<u>112</u>	<u>156</u>	<u>213</u>	<u>249</u>	<u>301</u>	<u>339</u>	<u>375</u>	<u>429</u>	<u>467</u>
<u>113</u>	<u>159</u>	<u>214</u>	<u>250</u>	<u>302</u>	<u>340</u>	<u>379</u>	<u>430</u>	<u>468</u>
<u>114</u>	<u>161</u>	<u>215</u>	<u>252</u>	<u>303</u>	<u>341</u>	<u>381</u>	<u>430</u>	<u>469</u>
<u>115</u>	<u>163</u>	<u>216</u>	<u>256</u>	<u>304</u>	<u>342</u>	<u>382</u>	<u>431</u>	<u>470</u>
<u>116</u>	<u>164</u>	<u>217</u>	<u>257</u>	<u>305</u>	<u>345</u>	<u>383</u>	<u>435</u>	<u>471</u>
<u>121</u>	<u>165</u>	<u>218</u>	<u>258</u>	<u>306</u>	<u>346</u>	<u>384</u>	<u>435</u>	<u>472</u>
<u>122</u>	<u>166</u>	<u>219</u>	<u>259</u>	<u>308</u>	<u>347</u>	<u>385</u>	<u>437</u>	<u>473</u>
<u>123</u>	<u>167</u>	<u>220</u>	<u>260</u>	<u>312</u>	<u>348</u>	<u>386</u>	<u>438</u>	<u>474</u>
<u>124</u>	<u>168</u>	<u>221</u>	<u>261</u>	<u>313</u>	<u>349</u>	<u>401</u>	<u>439</u>	<u>475</u>
<u>125</u>	<u>169</u>	<u>222</u>	<u>262</u>	<u>314</u>	<u>350</u>	<u>402</u>	<u>440</u>	<u>479</u>
<u>126</u>	<u>170</u>	<u>223</u>	<u>263</u>	<u>315</u>	<u>352</u>	<u>403</u>	<u>441</u>	<u>481</u>
<u>127</u>	<u>171</u>	<u>224</u>	<u>264</u>	<u>316</u>	<u>356</u>	<u>404</u>	<u>442</u>	<u>482</u>
<u>128</u>	<u>172</u>	<u>225</u>	<u>265</u>	<u>317</u>	<u>357</u>	<u>405</u>	<u>445</u>	<u>483</u>
<u>129</u>	<u>173</u>	<u>226</u>	<u>266</u>	<u>318</u>	<u>358</u>	<u>406</u>	<u>446</u>	<u>484</u>
<u>130</u>	<u>174</u>	<u>227</u>	<u>267</u>	<u>319</u>	<u>359</u>	<u>408</u>	<u>447</u>	<u>485</u>
<u>131</u>	<u>175</u>	<u>228</u>	<u>268</u>	<u>320</u>	<u>360</u>	<u>412</u>	<u>448</u>	<u>486</u>
<u>135</u>	<u>179</u>	<u>229</u>	<u>269</u>	<u>321</u>	<u>361</u>	<u>413</u>	<u>449</u>	
<u>137</u>	<u>181</u>	<u>230</u>	<u>270</u>	<u>322</u>	<u>362</u>	<u>414</u>	<u>450</u>	
<u>138</u>	<u>182</u>	<u>231</u>	<u>271</u>	<u>323</u>	<u>363</u>	<u>415</u>	<u>452</u>	
<u>139</u>	<u>183</u>	<u>235</u>	<u>272</u>	<u>325</u>	<u>364</u>	<u>416</u>	<u>456</u>	
<u>140</u>	<u>184</u>	<u>237</u>	<u>273</u>	<u>327</u>	<u>365</u>	<u>417</u>	<u>457</u>	
<u>141</u>	<u>185</u>	<u>238</u>	<u>274</u>	<u>328</u>	<u>366</u>	<u>418</u>	<u>458</u>	
<u>142</u>	<u>201</u>	<u>239</u>	<u>275</u>	<u>329</u>	<u>367</u>	<u>419</u>	<u>459</u>	
<u>145</u>	<u>202</u>	<u>240</u>	<u>279</u>	<u>330</u>	<u>368</u>	<u>420</u>	<u>460</u>	

Village Floor Plan 1

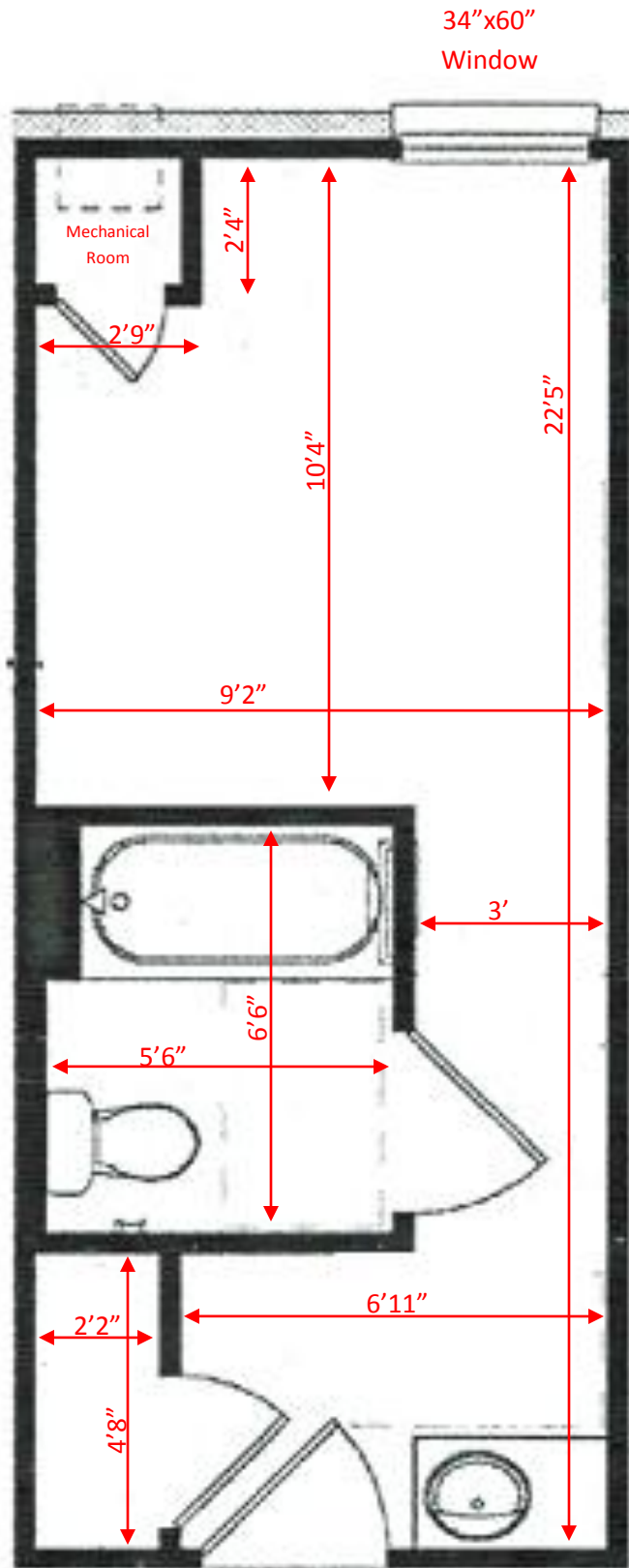

*Room floor plans may be mirror image depending on location.

*All Dimensions are approximate and may vary from room to room.

Village Floor Plan 2

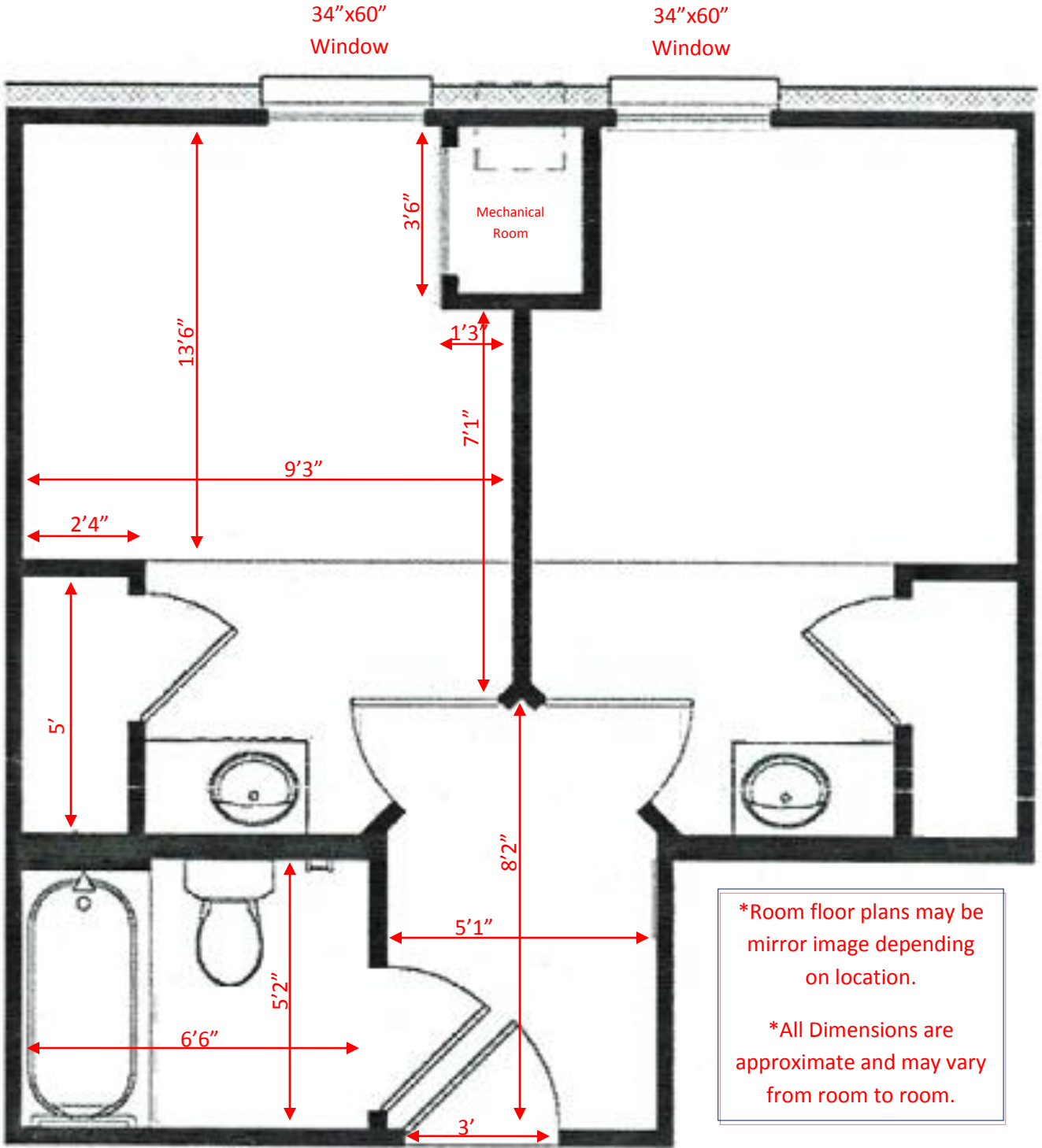

*Room floor plans may be mirror image depending on location.

*All Dimensions are approximate and may vary from room to room.

Village Floor Plan 3

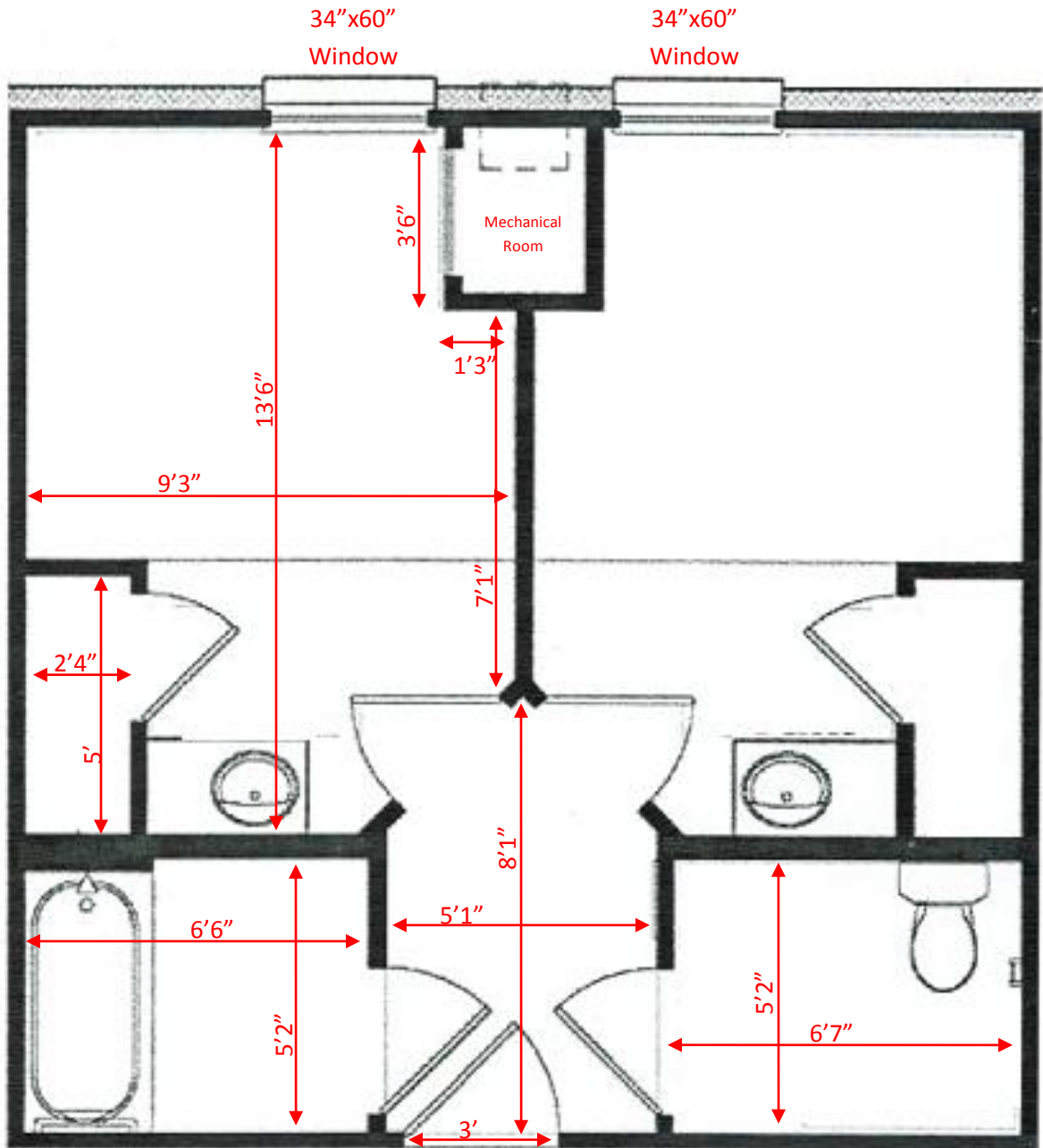

*Room floor plans may be mirror image depending on location.

*All Dimensions are approximate and may vary from room to room.

Village Floor Plan 4

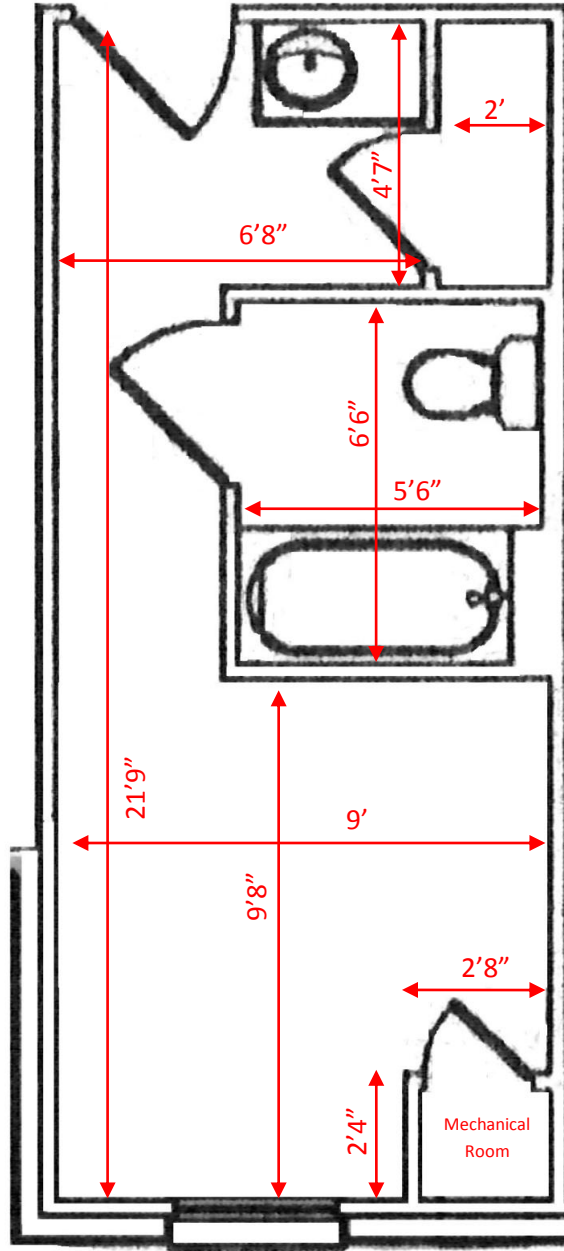

*Room floor plans may be mirror image depending on location.

*All Dimensions are approximate and may vary from room to room.

34"x60"
Window

Village Floor Plan 5

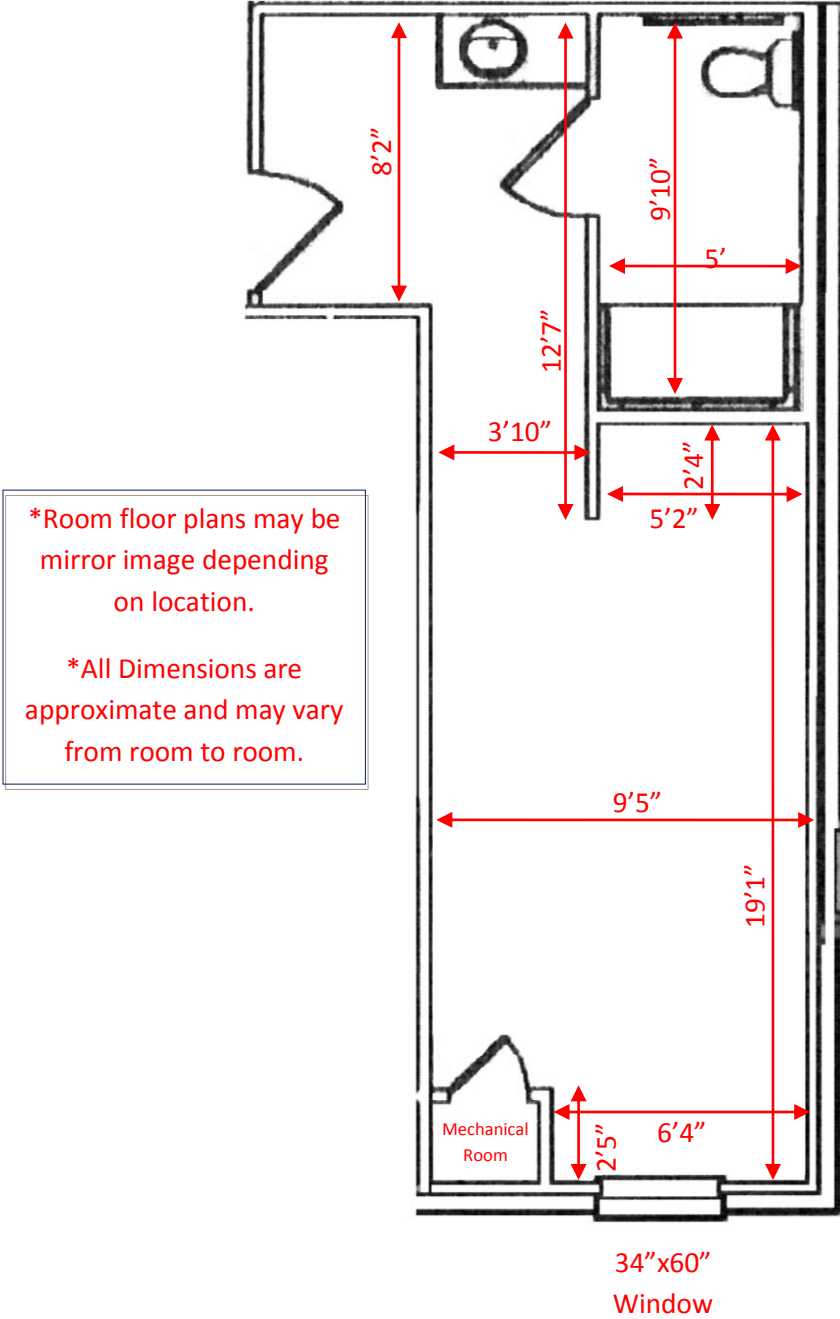

Village Floor Plan 6

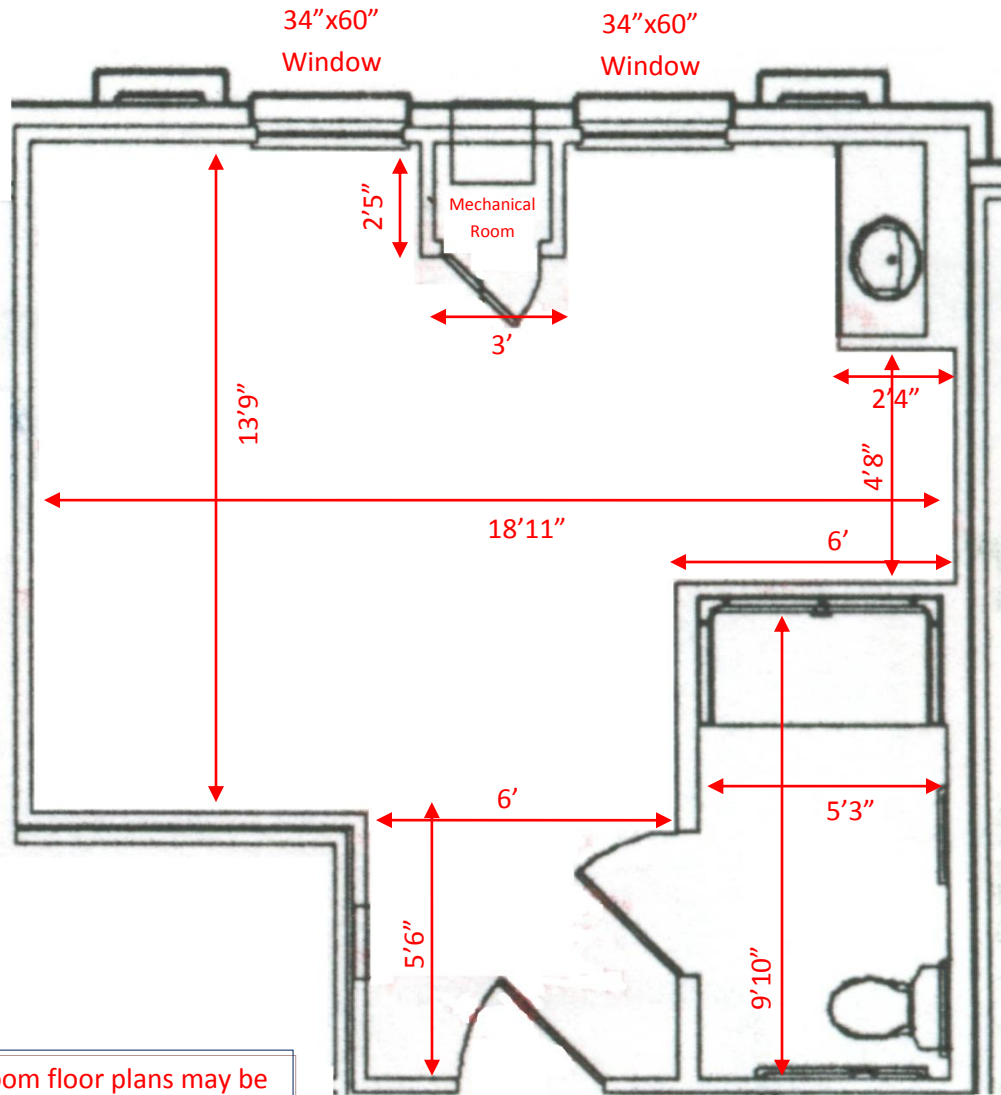

*Room floor plans may be mirror image depending on location.

*All Dimensions are approximate and may vary from room to room.

Village Floor Plan 7

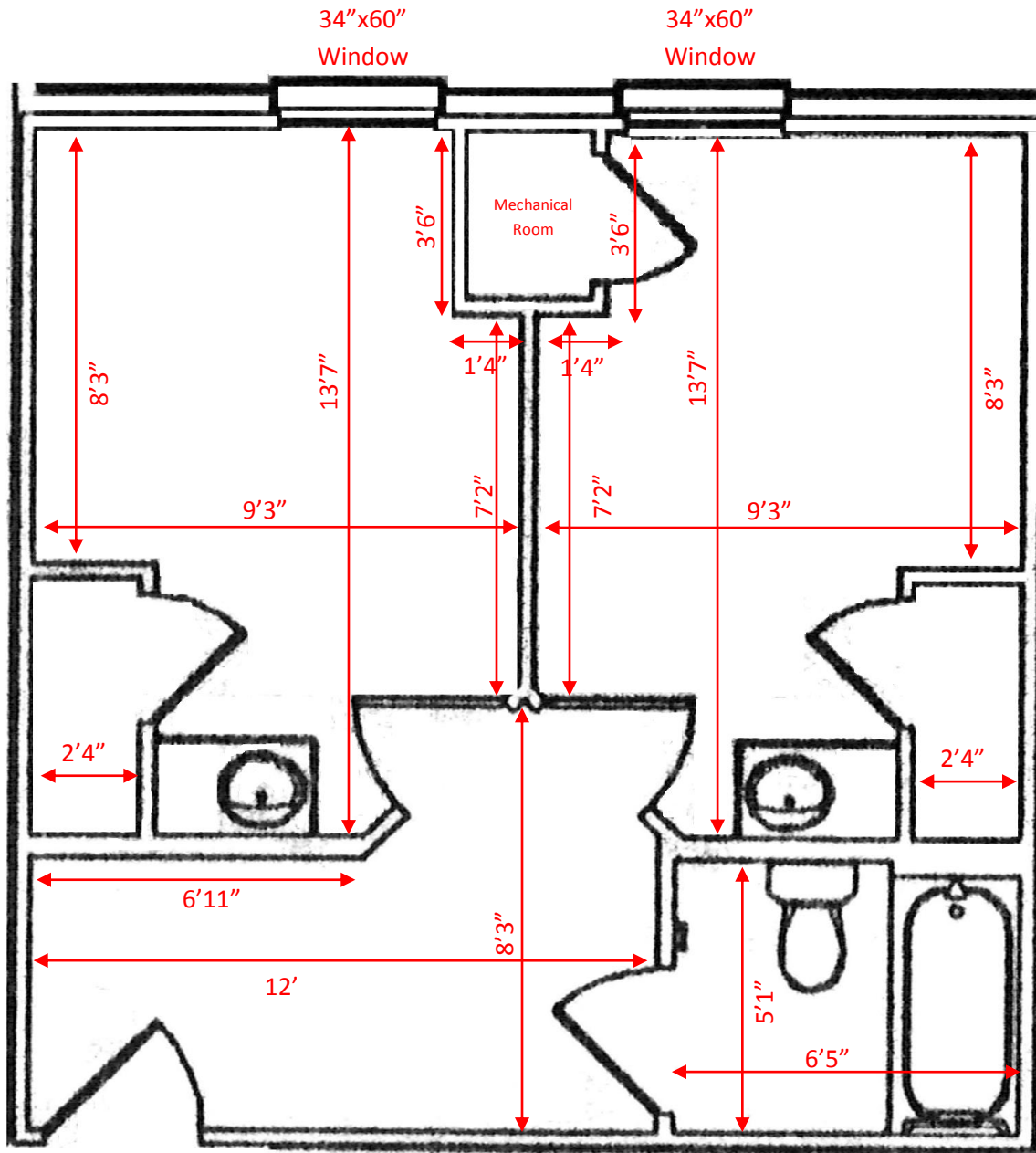

*Room floor plans may be mirror image depending on location.

*All Dimensions are approximate and may vary from room to room.

Village Floor Plan 8

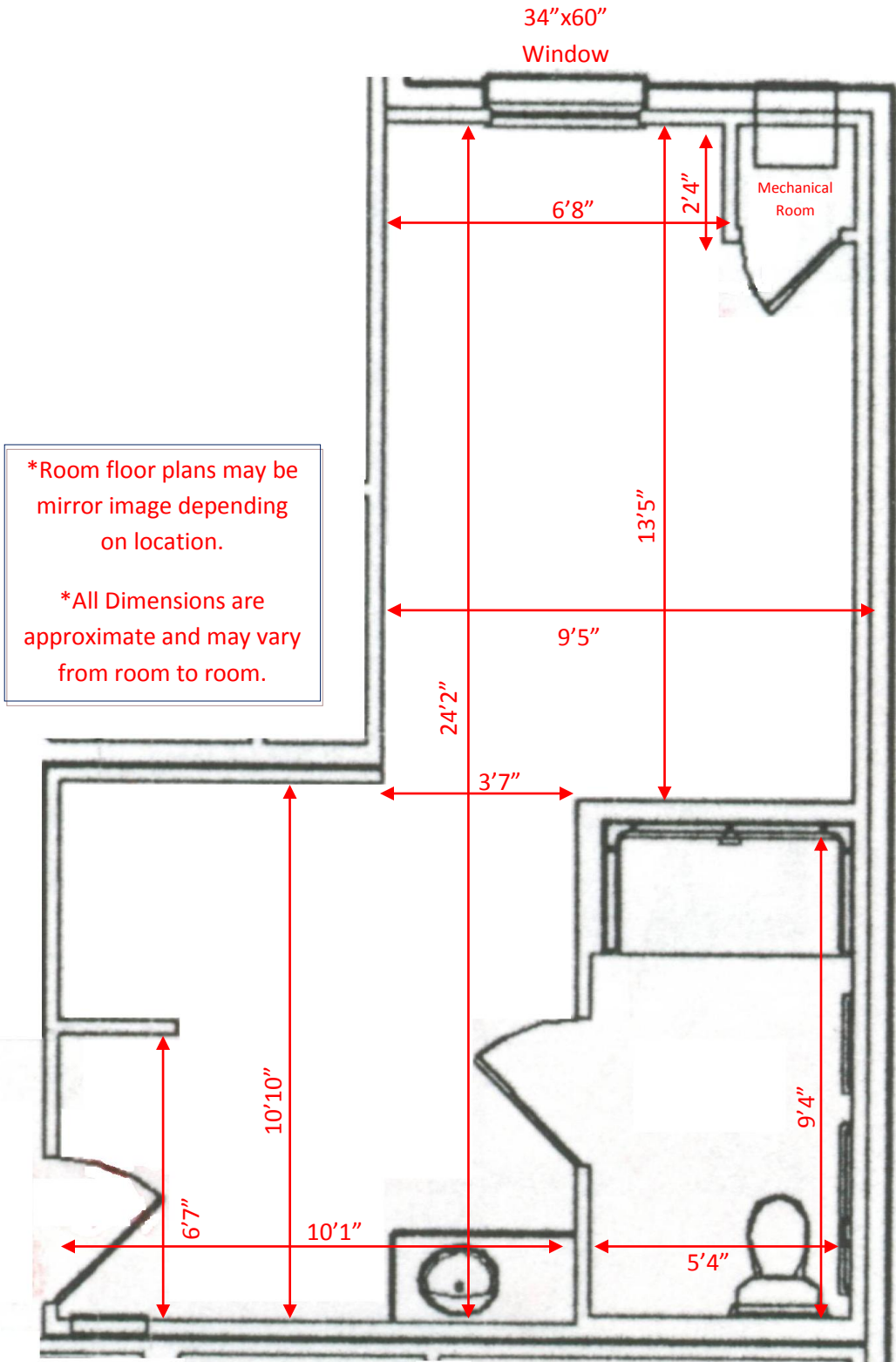

Village Floor Plan 9

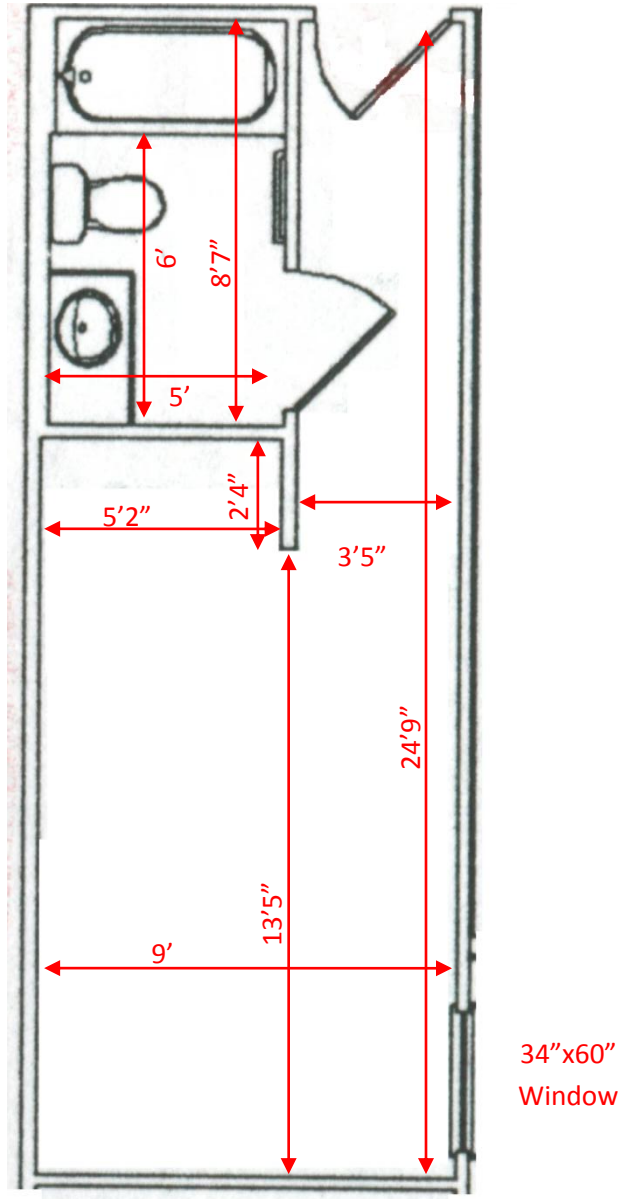

*Room floor plans may be mirror image depending on location.

*All Dimensions are approximate and may vary from room to room.

Zink - Allen

Room Number			
<u>101</u>	<u>207</u>	<u>310</u>	<u>413</u>
<u>103</u>	<u>208</u>	<u>311</u>	<u>414</u>
<u>104</u>	<u>209</u>	<u>312</u>	<u>415</u>
<u>105</u>	<u>210</u>	<u>313</u>	<u>416</u>
<u>106</u>	<u>211</u>	<u>314</u>	<u>417</u>
<u>107</u>	<u>212</u>	<u>315</u>	<u>418</u>
<u>108</u>	<u>213</u>	<u>316</u>	<u>419</u>
<u>109</u>	<u>214</u>	<u>317</u>	<u>420</u>
<u>110</u>	<u>215</u>	<u>318</u>	<u>421</u>
<u>111</u>	<u>216</u>	<u>319</u>	<u>422</u>
<u>112</u>	<u>217</u>	<u>320</u>	
<u>113</u>	<u>218</u>	<u>321</u>	
<u>114</u>	<u>219</u>	<u>322</u>	
<u>116</u>	<u>220</u>	<u>401</u>	
<u>117</u>	<u>221</u>	<u>402</u>	
<u>118</u>	<u>222</u>	<u>403</u>	
<u>119</u>	<u>301</u>	<u>404</u>	
<u>120</u>	<u>302</u>	<u>405</u>	
<u>122</u>	<u>303</u>	<u>406</u>	
<u>201</u>	<u>304</u>	<u>407</u>	
<u>202</u>	<u>305</u>	<u>408</u>	
<u>203</u>	<u>306</u>	<u>409</u>	
<u>204</u>	<u>307</u>	<u>410</u>	
<u>205</u>	<u>308</u>	<u>411</u>	
<u>206</u>	<u>309</u>	<u>412</u>	

Zink - Allen Floor Plan 1

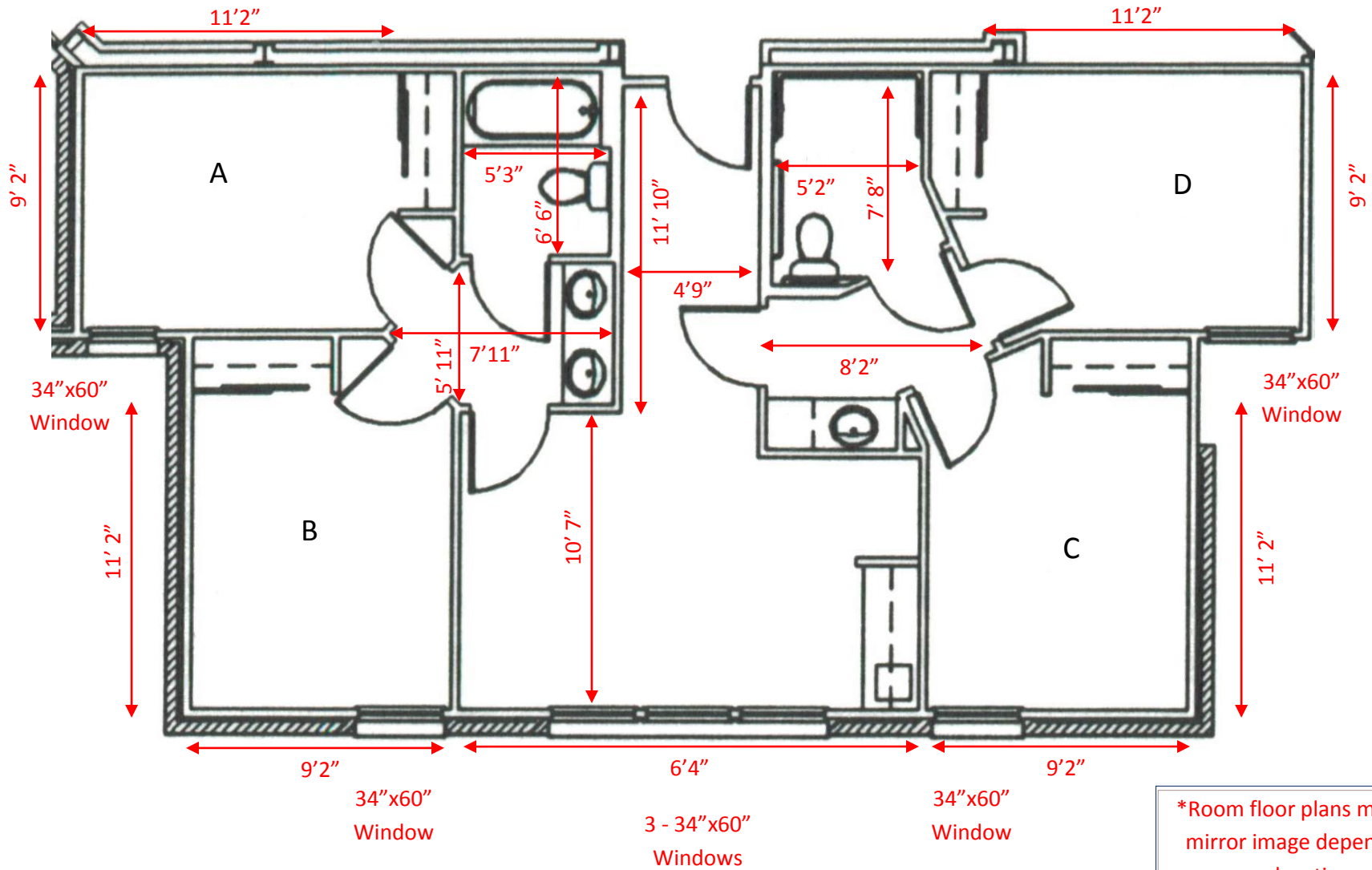

*Room floor plans may be mirror image depending on location.

*All Dimensions are approximate and may vary from room to room.

Zink - Allen Floor Plan 2

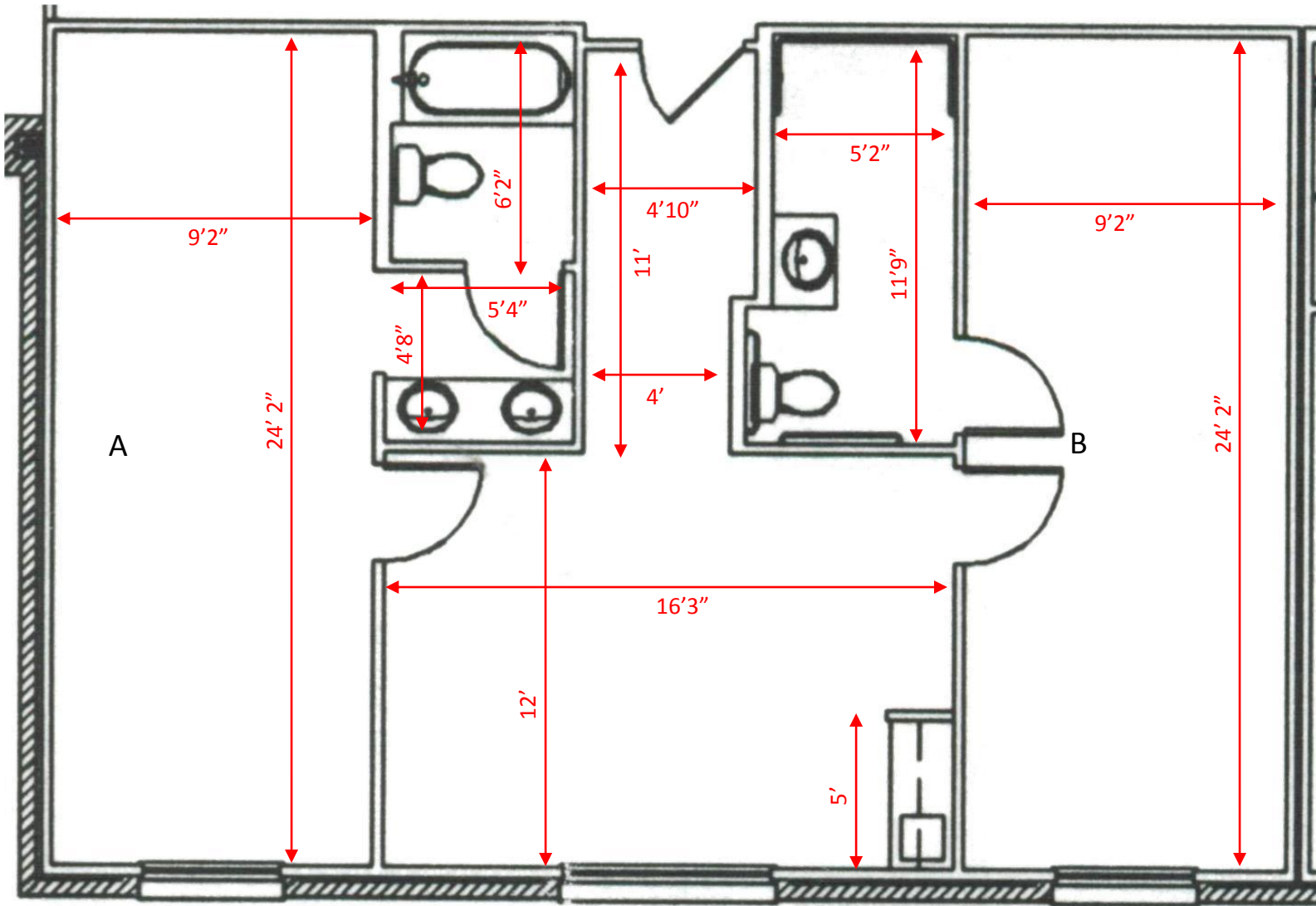

46" x 46"
Window

70" x 58"
Window

*Room floor plans may be mirror image depending on location.

*All Dimensions are approximate and may vary from room to room.

46" x 46"
Window

Zink - Allen Floor Plan 3

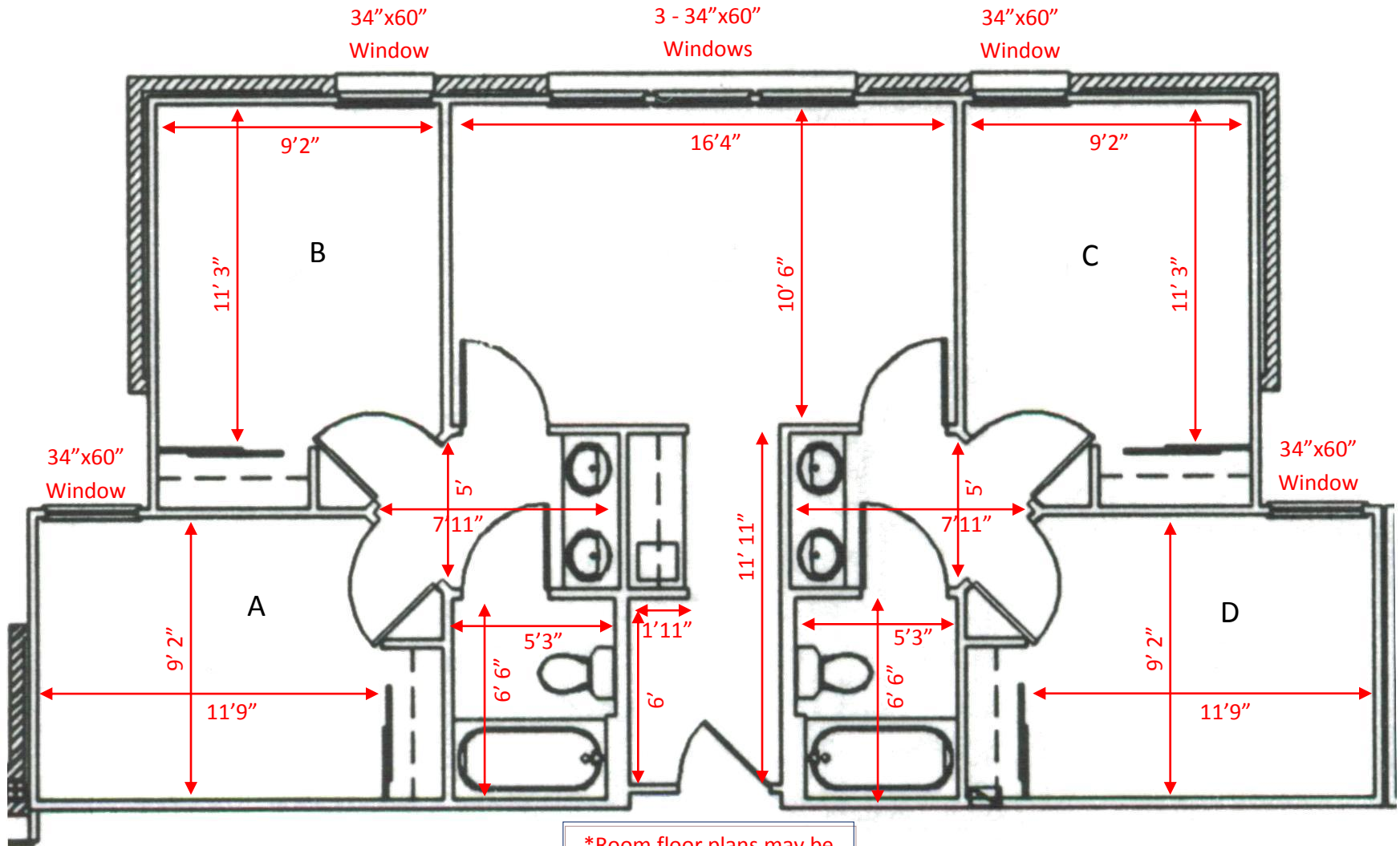

*Room floor plans may be mirror image depending on location.

*All Dimensions are approximate and may vary from room to room.

Zink - Allen Floor Plan 4

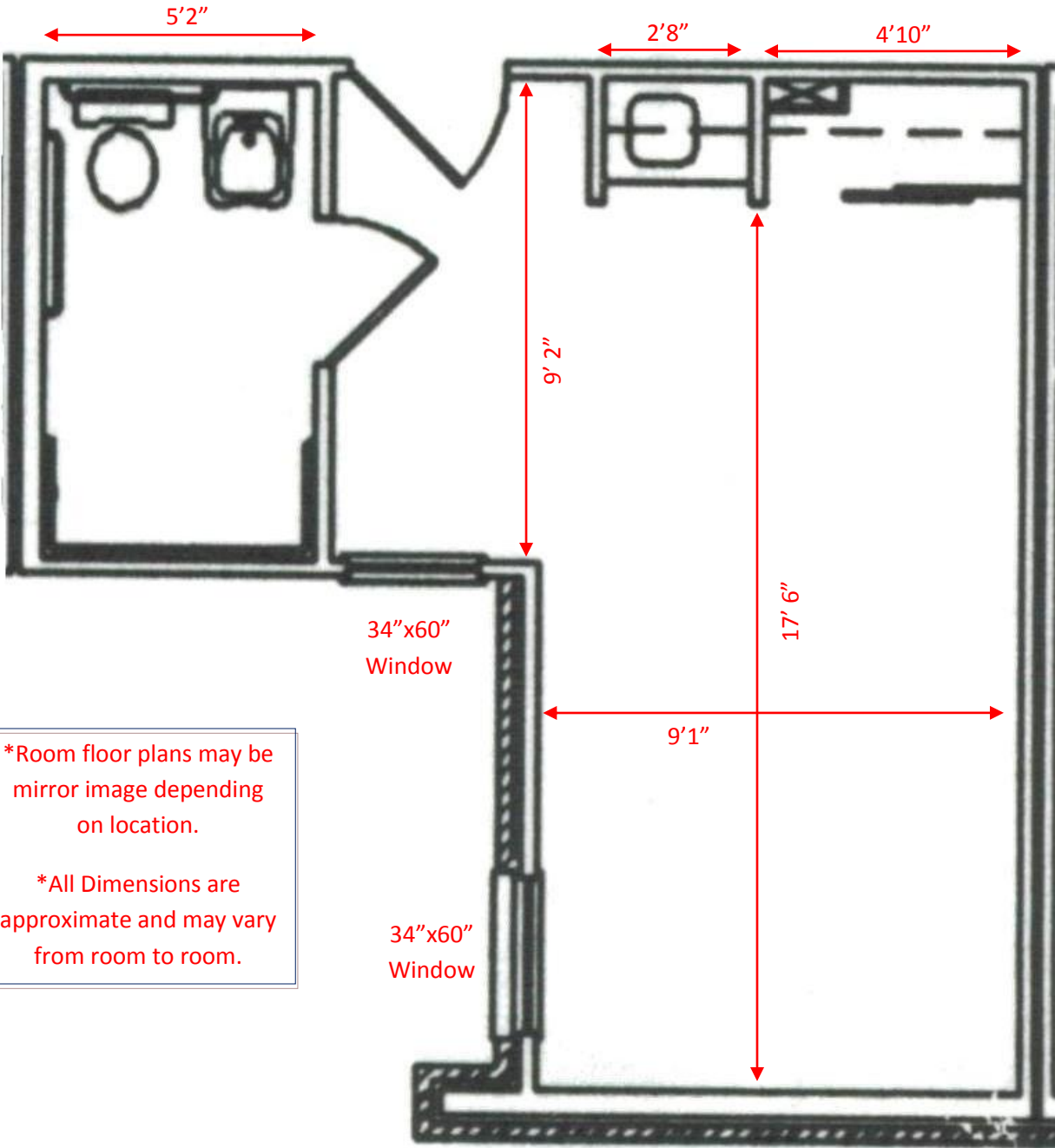

*Room floor plans may be mirror image depending on location.

*All Dimensions are approximate and may vary from room to room.

Zink - Allen Floor Plan 5

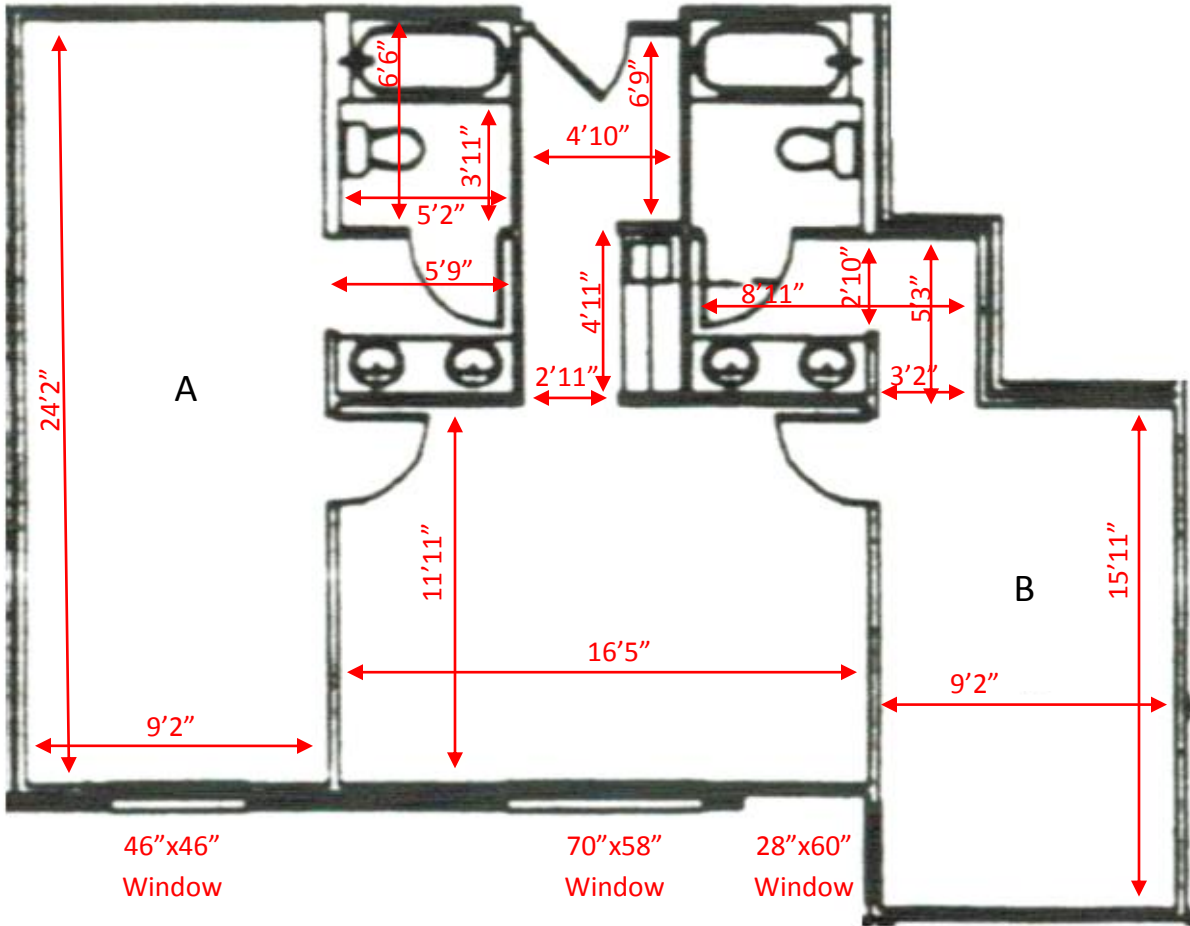

*Room floor plans may be mirror image depending on location.

*All Dimensions are approximate and may vary from room to room.

Zink - Allen Floor Plan 6

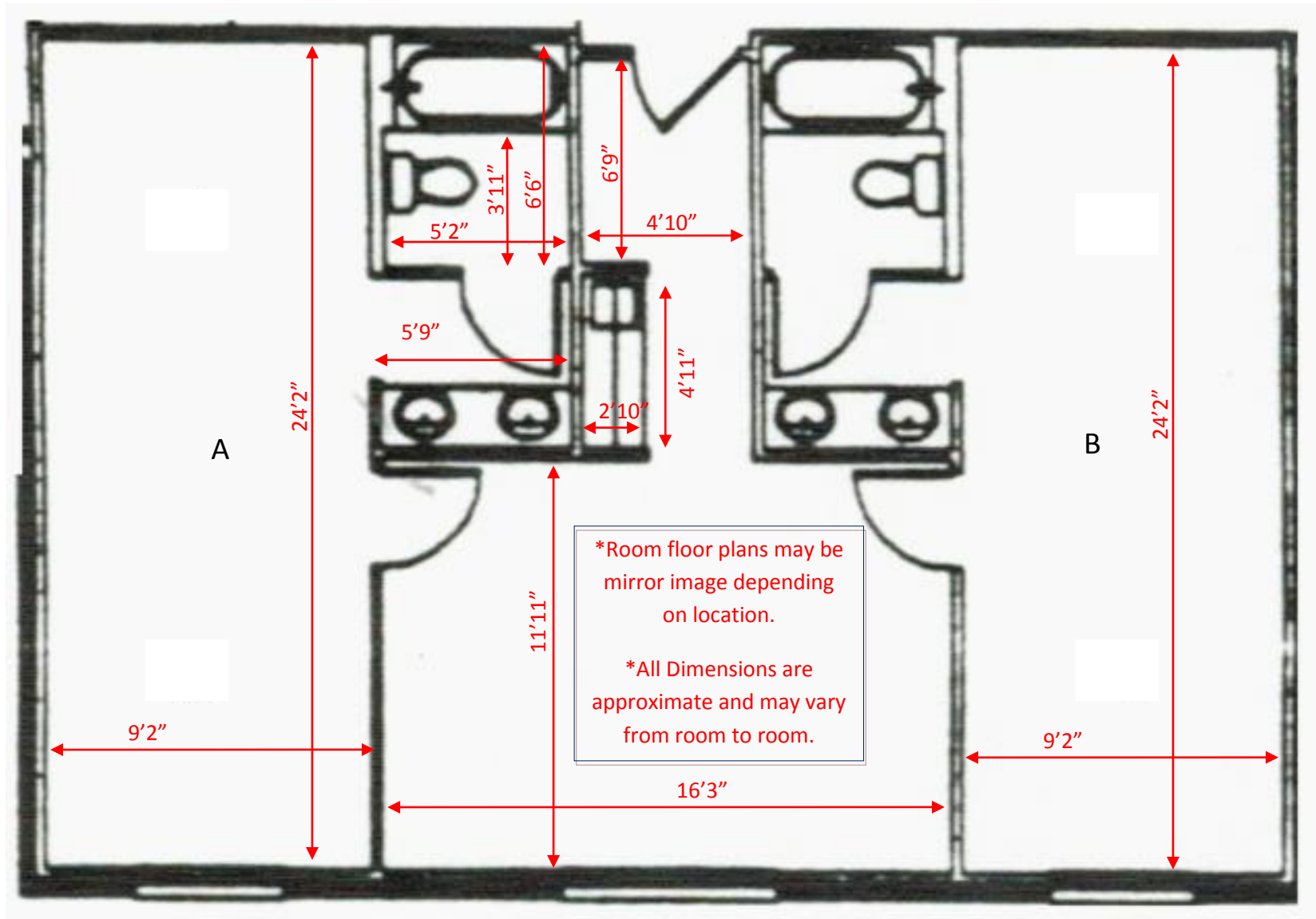

Zink - Allen Floor Plan 7

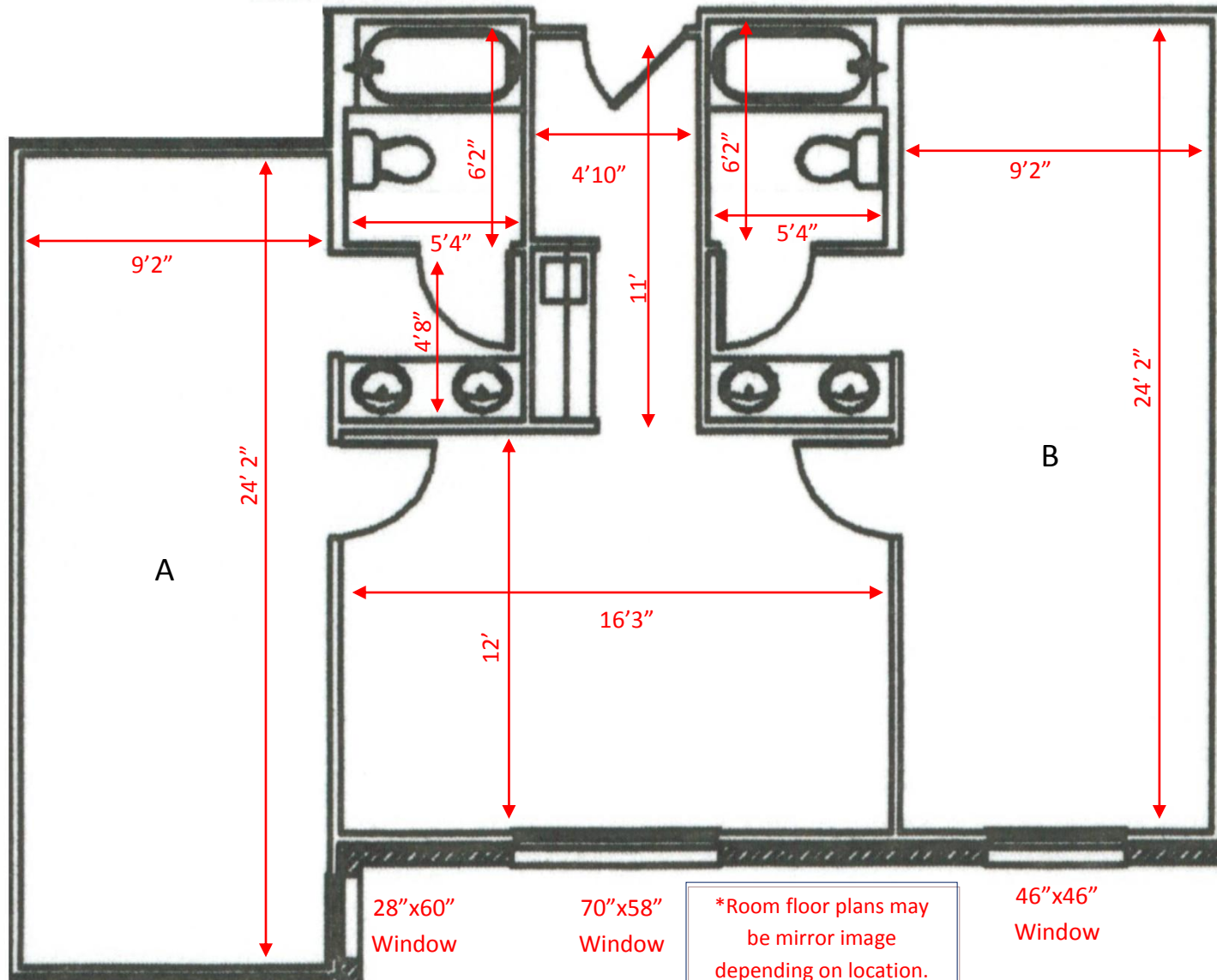

*Room floor plans may be mirror image depending on location.

*All Dimensions are approximate and may vary from room to room.

Floor plan Type	Room Number			
Booker - Stinchcomb				
<u>Booker-Stinchcomb 1</u>	102	202	302	402
	103	203	303	403
	104	204	304	404
	105	205	305	405
	106	206	306	406
	107	207	307	407
	108	208	308	408
	109	209	309	409
	110	210	310	410
	111	211	311	411
	112	212	312	412
	113	213	313	413
	114	214	314	414
	115	215	315	415
	116	216	316	416
	117	217	317	417
	118	218	318	418
	119	219	319	419
	120	220	320	420
	121	221	321	421
	122	222	322	422
	124	224	324	424
	126	225	325	425
	128	226	326	426
	129	227	327	427
	130	228	328	428
	131	229	329	429
	132	230	330	430
	133	231	331	431
	134	232	332	432
	137	233	333	433
	138	234	334	434
	139	235	335	435
	140	236	336	436
	141	237	337	437
	142	238	338	438
	144	239	339	439
		240	340	440
		241	341	441
		242	342	442
		244	344	444

<u>Booker-Stinchcomb 2</u>	101	201	301	401
	143	243	343	443

<u>Booker - Stinchcomb 3</u>	136			
------------------------------	-----	--	--	--

<u>Booker - Stinchcomb 4</u>	123	223	323	423
------------------------------	-----	-----	-----	-----

Floor Plan Type	Room Number			
Patchin - Jones				

<u>Patchin-Jones Floor Plan 1</u>	107	116		
-----------------------------------	-----	-----	--	--

<u>Patchin-Jones Floor Plan 2</u>	113	111		
-----------------------------------	-----	-----	--	--

<u>Patchin-Jones Floor Plan 3</u>	101	201	301	401
	103	203	303	403
	104	204	304	404
	105	205	305	405
	106	206	306	406
	108	207	307	407
	110	208	308	408
	112	210	310	410
	114	212	312	412
	117	214	314	414
	118	216	316	416
	119	217	317	417
	120	218	318	418
	122	219	319	419
		220	320	420
		222	322	422

<u>Patchin-Jones Floor Plan 4</u>	202	302	402	
	221	321	421	

<u>Patchin-Jones Floor Plan 5</u>	209	215		
-----------------------------------	-----	-----	--	--

<u>Patchin-Jones Floor Plan 6</u>	211	311	411	
	213	313	413	

<u>Patchin-Jones Floor Plan 7</u>	109	315	415	
	309	409		

Floor Plan Type	Room Number			
Village C&D				
<u>Village Floor Plan 1</u>	101	201	301	401
	103	203	303	403
	104	204	304	404
	106	206	306	406
	108	208	308	408
	113	213	313	413
	114	214	314	414
	115	215	315	415
	116	216	316	416
	117	217	317	417
	118	218	318	418
	119	219	319	419
	120	220	320	420
	127	223	323	423
	128	224	324	424
	129	225	325	425
	130	226	326	426
	135	227	327	427
	137	228	328	428
	139	229	329	429
	140	230	330	430
	147	235	335	435
	148	237	337	437
	150	239	339	439
	152	240	340	440
	157	242	342	442
	158	245	345	445
	159	247	347	447
	160	248	348	448
	161	250	350	450
	162	252	352	452
	163	257	357	457
	164	258	358	458
	167	259	359	459
	168	260	360	460
	169	261	361	461
	171	262	362	462
	179	263	363	463
	181	264	364	464
	183	267	367	467

	184	268	368	468
	186	269	369	469
		270	370	470
		271	371	471
		272	372	472
		272	373	472
		274	374	474
		279	379	479
		281	381	481
		283	383	483
		284	384	484
		286	386	486

<u>Village Floor Plan 2</u>	102	202	302	402
	105	205	305	405
	138	238	338	438
	141	241	341	441
	146	246	346	446
	149	249	349	449
	182	282	382	482
	185	285	385	485

<u>Village Floor Plan 4</u>	121	221	321	421
	166	266	366	466

<u>Village Floor Plan 5</u>	122	222	322	422
	165	265	365	465

<u>Village Floor Plan 7</u>	112	212	312	412
	131	231	331	431
	156	256	356	456
	175	275	375	475

Floor Plan Type	Room Number			
Village CASNR				
<u>Village Floor Plan 1</u>	105	202	302	402
	130	203	303	403
	131	205	305	405
	133	230	330	430
		231	331	431
		233	333	433

<u>Village Floor Plan 2</u>	107	207	307	407
	109	209	309	409
	112	212	312	412
	123	223	323	423
	126	226	326	426
		228	328	428

<u>Village Floor Plan 3</u>	111	211	311	411
	114	214	314	414
	121	221	321	421
	124	224	324	424

<u>Village Floor Plan 6</u>	128
-----------------------------	-----

<u>Village Floor Plan 8</u>	108	208	308	408
	127	227	327	427

<u>Village Floor Plan 9</u>	115	215	315	415
	120	220	320	420

Floor Plan Type	Room Number			
Village HES				
<u>Village Floor Plan 1</u>	105	202	302	402
	133	203	303	403
		204	304	404
		230	330	430
		231	331	431
		233	333	433

<u>Village Floor Plan 2</u>	107	207	307	407
	109	209	309	409
	112	212	312	412
	123	223	323	423
	126	226	326	426
		228	328	428

<u>Village Floor Plan 3</u>	111	211	311	411
	114	214	314	414
	121	221	321	421
	124	224	324	424

<u>Village Floor Plan 8</u>	108	208	308	408
	127	227	327	427

<u>Village Floor Plan 9</u>	115	215	315	415
	120	220	320	420

Floor Plan Type	Room Number			
Village E&F				
<u>Village Floor Plan 1</u>	103	201	301	401
	104	203	303	403
	106	204	304	404
	108	206	306	406
	113	208	308	408
	114	213	313	413
	115	214	314	414
	116	215	315	415
	123	216	316	416
	124	217	317	417
	125	218	318	418
	126	219	319	419
	127	220	320	420
	128	223	323	423
	129	224	325	425
	130	225	327	427
	135	226	328	428
	137	227	329	429
	139	228	330	430
	140	229	335	435
	142	230	330	430
	145	235	335	435
	147	237	337	437
	148	239	339	439
	150	240	340	440
	152	242	342	442
	159	245	345	445
	161	247	347	447
	163	248	348	448
	164	250	350	450
	167	252	352	452
	168	257	357	457
	169	258	358	458
	170	259	359	459
	171	260	360	460
	172	261	361	461
	173	262	362	462
	174	263	363	463
	179	264	364	464
	181	267	367	467

	183	268	368	468
	184	269	369	469
		270	370	470
		271	371	471
		272	372	472
		272	373	472
		274	374	474
		279	379	479
		281	381	481
		283	383	483
		284	384	484
		286	386	486

<u>Village Floor Plan 2</u>	102	202	302	402
	105	205	305	405
	138	238	338	438
	141	241	341	441
	146	246	346	446
	149	249	349	449
	182	282	382	482
	185	285	385	485

<u>Village Floor Plan 4</u>	122	222	322	422
	165	265	365	465

<u>Village Floor Plan 5</u>	121	221	321	421
	166	266	366	466

<u>Village Floor Plan 7</u>	112	212	312	412
	131	231	331	431
	156	256	356	456
	175	275	375	475

Floor Plan Type	Room Number		
Zink - Allen			
<u>Zink-Allen Floor Plan 1</u>	107	116	

<u>Zink-Allen Floor Plan 2</u>	111	113	
--------------------------------	-----	-----	--

<u>Zink-Allen Floor Plan 3</u>	101	201	301	401
	103	203	303	403
	104	204	304	404
	105	205	305	405
	106	206	306	406
	108	207	307	407
	110	208	308	408
	112	210	310	410
	114	212	312	412
	117	214	314	414
	118	216	316	416
	119	217	317	417
	120	218	318	418
	122	219	319	419
		220	320	420
		222	322	422

<u>Zink-Allen Floor Plan 4</u>	202	302	402
	221	321	421

<u>Zink-Allen Floor Plan 5</u>	209	215	
--------------------------------	-----	-----	--

<u>Zink-Allen Floor Plan 6</u>	211	311	411
	213	313	413

<u>Zink-Allen Floor Plan 7</u>	109	315	415
	309	409	

Apartment Style



Bost		
Room Number		
<u>101</u>	<u>201</u>	<u>301</u>
<u>102</u>	<u>202</u>	<u>302</u>
<u>103</u>	<u>203</u>	<u>303</u>
<u>104</u>	<u>204</u>	<u>304</u>
<u>105</u>	<u>205</u>	<u>305</u>
<u>106</u>	<u>206</u>	<u>306</u>
<u>107</u>	<u>207</u>	<u>307</u>
<u>108</u>	<u>208</u>	<u>308</u>

Davis		
Room Number		
<u>101</u>	<u>201</u>	<u>301</u>
<u>102</u>	<u>202</u>	<u>302</u>
<u>103</u>	<u>203</u>	<u>303</u>
<u>104</u>	<u>204</u>	<u>304</u>
<u>105</u>	<u>205</u>	<u>305</u>
<u>106</u>	<u>206</u>	<u>306</u>
<u>107</u>	<u>207</u>	<u>307</u>
<u>108</u>	<u>208</u>	<u>308</u>
<u>109</u>	<u>209</u>	<u>309</u>
<u>110</u>	<u>210</u>	<u>310</u>
<u>111</u>	<u>211</u>	<u>311</u>
<u>112</u>	<u>212</u>	<u>312</u>

Morsani - Smith

Room Number

<u>101</u>	<u>201</u>	<u>301</u>
<u>102</u>	<u>202</u>	<u>302</u>
<u>103</u>	<u>203</u>	<u>303</u>
<u>104</u>	<u>204</u>	<u>304</u>
<u>105</u>	<u>205</u>	<u>305</u>
<u>106</u>	<u>206</u>	<u>306</u>
<u>107</u>	<u>207</u>	<u>307</u>
<u>108</u>	<u>208</u>	<u>308</u>
<u>109</u>	<u>209</u>	<u>309</u>
<u>110</u>	<u>210</u>	<u>310</u>
<u>111</u>	<u>211</u>	<u>311</u>
<u>112</u>	<u>212</u>	<u>312</u>
<u>113</u>	<u>213</u>	<u>313</u>
<u>114</u>	<u>214</u>	<u>314</u>
<u>115</u>	<u>215</u>	<u>315</u>
<u>116</u>	<u>216</u>	<u>316</u>
<u>117</u>	<u>217</u>	<u>317</u>
<u>118</u>	<u>218</u>	<u>318</u>
<u>119</u>	<u>219</u>	<u>319</u>
<u>120</u>	<u>220</u>	<u>320</u>

Sitlington

Room Number

<u>101</u>	<u>201</u>	<u>301</u>
<u>102</u>	<u>202</u>	<u>302</u>
<u>103</u>	<u>203</u>	<u>303</u>
<u>104</u>	<u>204</u>	<u>304</u>
<u>105</u>	<u>205</u>	<u>305</u>
<u>106</u>	<u>206</u>	<u>306</u>
<u>107</u>	<u>207</u>	<u>307</u>
<u>108</u>	<u>208</u>	<u>308</u>

Young

Room Number

<u>101</u>	<u>201</u>	<u>301</u>
<u>102</u>	<u>202</u>	<u>302</u>
<u>103</u>	<u>203</u>	<u>303</u>
<u>104</u>	<u>204</u>	<u>304</u>
<u>105</u>	<u>205</u>	<u>305</u>
<u>106</u>	<u>206</u>	<u>306</u>
<u>107</u>	<u>207</u>	<u>307</u>
<u>108</u>	<u>208</u>	<u>308</u>

North Monroe Apartments Floor Plan 1

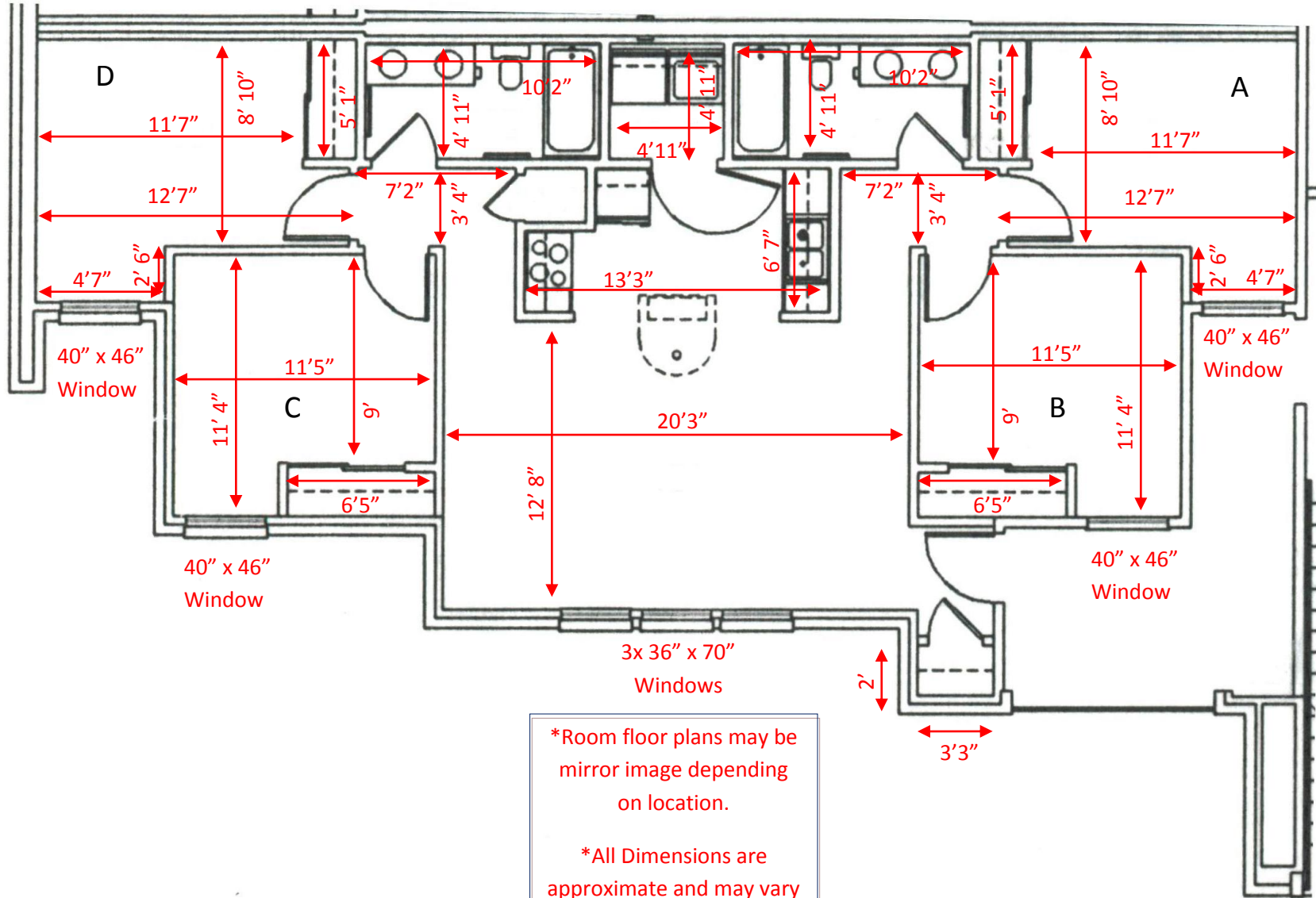

*Room floor plans may be mirror image depending on location.

*All Dimensions are approximate and may vary from room to room.

North Monroe Apartments Floor Plan 2

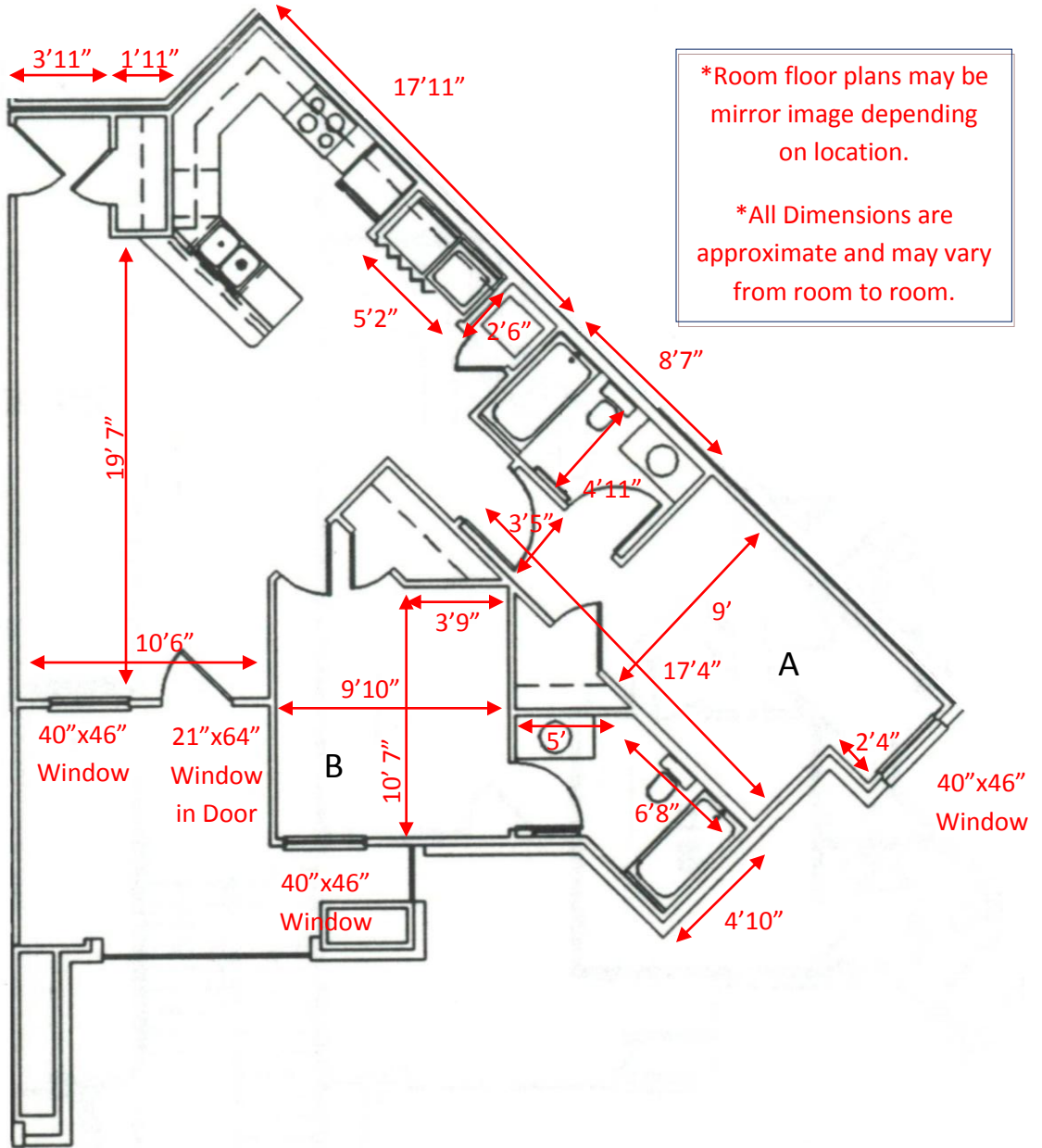

North Monroe Apartments Floor Plan 3

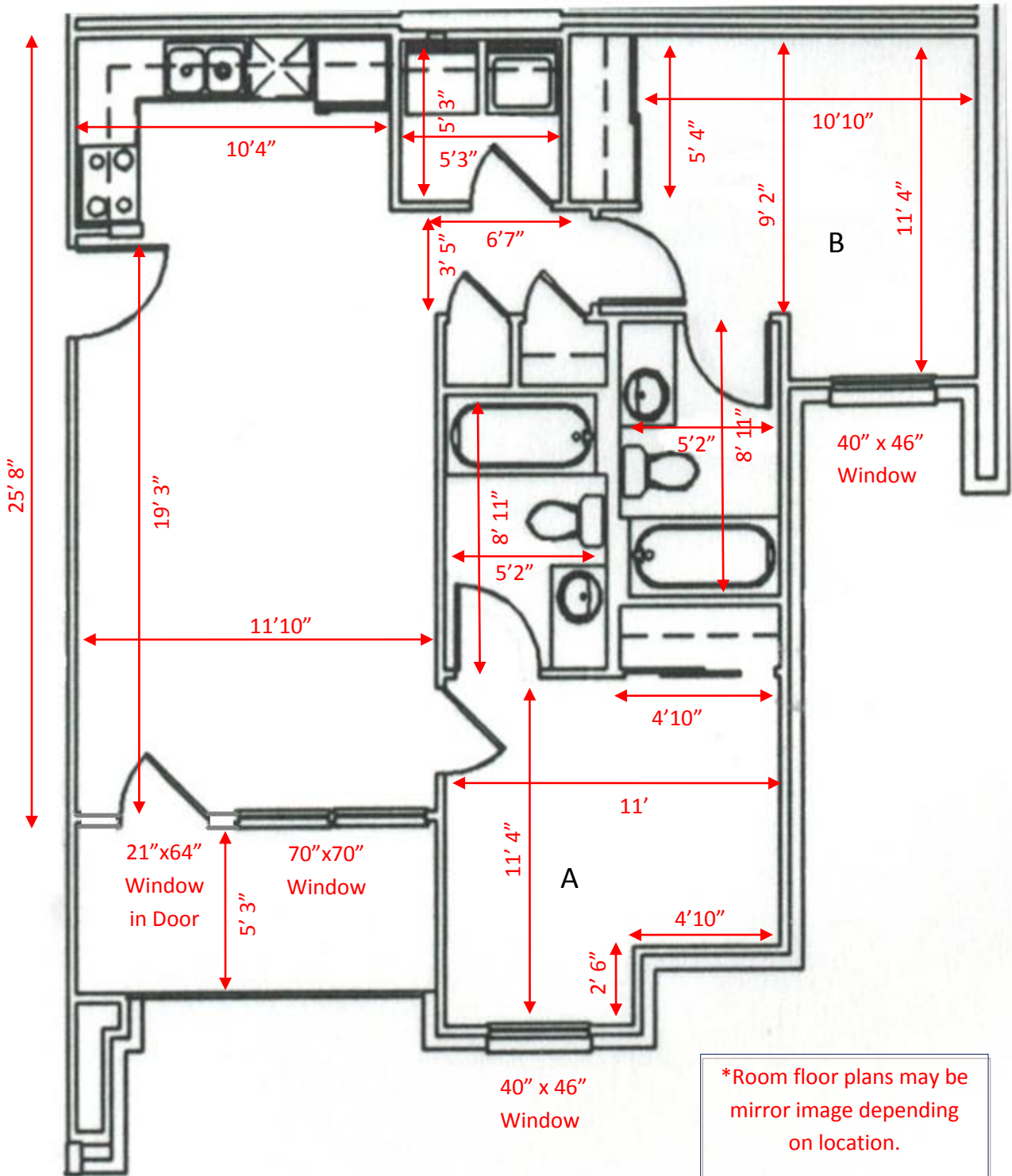

*Room floor plans may be mirror image depending on location.

*All Dimensions are approximate and may vary from room to room.

Kamm

Room Number

<u>101</u>	<u>201</u>	<u>301</u>
<u>102</u>	<u>202</u>	<u>302</u>
<u>103</u>	<u>203</u>	<u>303</u>
<u>104</u>	<u>204</u>	<u>304</u>
<u>105</u>	<u>205</u>	<u>305</u>
<u>106</u>	<u>206</u>	<u>306</u>
<u>107</u>	<u>207</u>	<u>307</u>
<u>108</u>	<u>208</u>	<u>308</u>

Peterson - Friend

Room Number

<u>101</u>	<u>201</u>	<u>301</u>
<u>102</u>	<u>202</u>	<u>302</u>
<u>103</u>	<u>203</u>	<u>303</u>
<u>104</u>	<u>204</u>	<u>304</u>
<u>105</u>	<u>205</u>	<u>305</u>
<u>106</u>	<u>206</u>	<u>306</u>
<u>107</u>	<u>207</u>	<u>307</u>
<u>108</u>	<u>208</u>	<u>308</u>
<u>109</u>	<u>209</u>	<u>309</u>
<u>110</u>	<u>210</u>	<u>310</u>
<u>111</u>	<u>211</u>	<u>311</u>
<u>112</u>	<u>212</u>	<u>312</u>
<u>113</u>	<u>213</u>	<u>313</u>
<u>114</u>	<u>214</u>	<u>314</u>
<u>115</u>	<u>215</u>	<u>315</u>
<u>116</u>	<u>216</u>	<u>316</u>
<u>117</u>	<u>217</u>	<u>317</u>
<u>118</u>	<u>218</u>	<u>318</u>
<u>119</u>	<u>219</u>	<u>319</u>
<u>120</u>	<u>220</u>	<u>320</u>

KPF Apartments Floor Plan 1

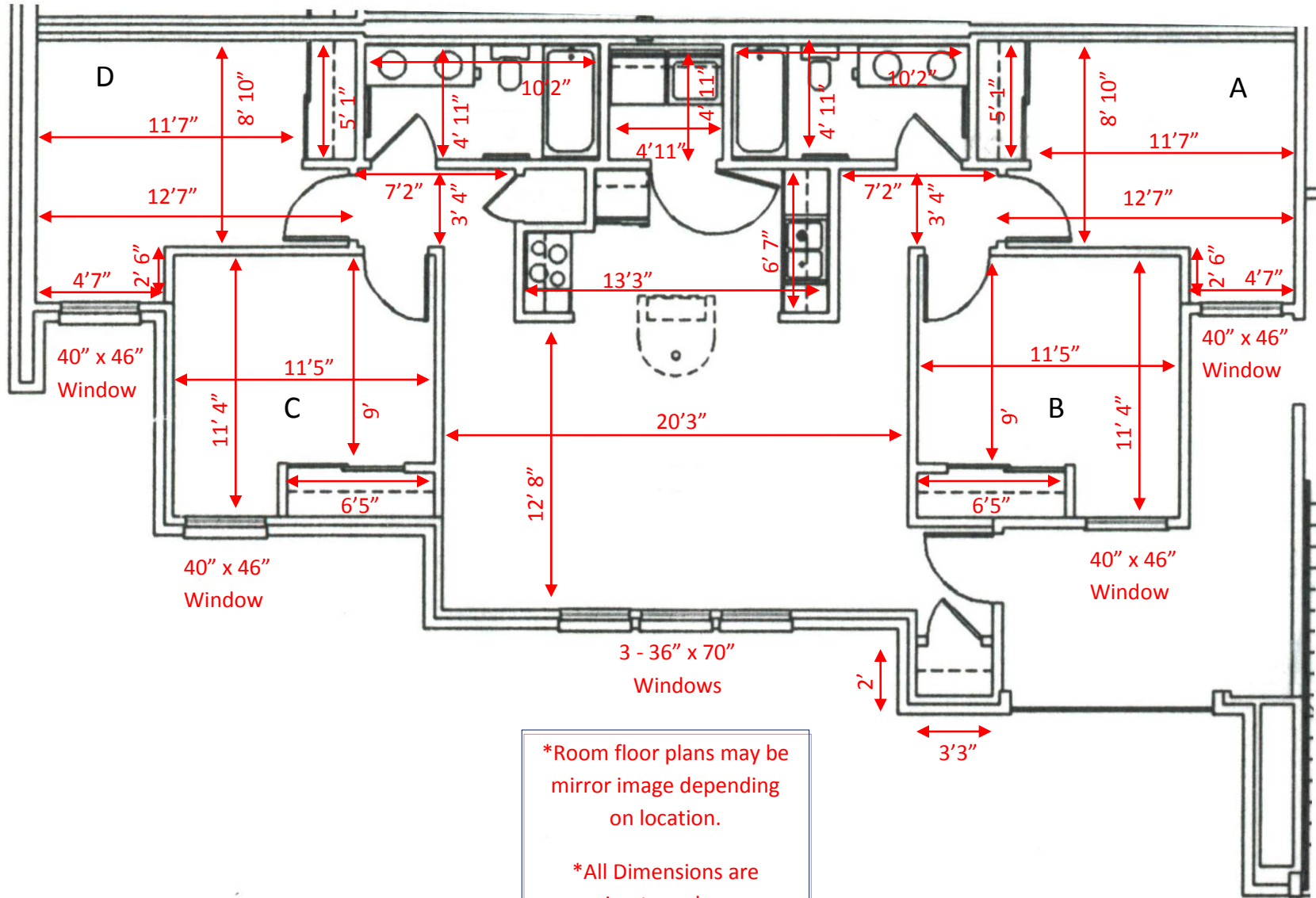

*Room floor plans may be mirror image depending on location.
*All Dimensions are approximate and may vary from room to room.

KPF Apartments Floor Plan 2

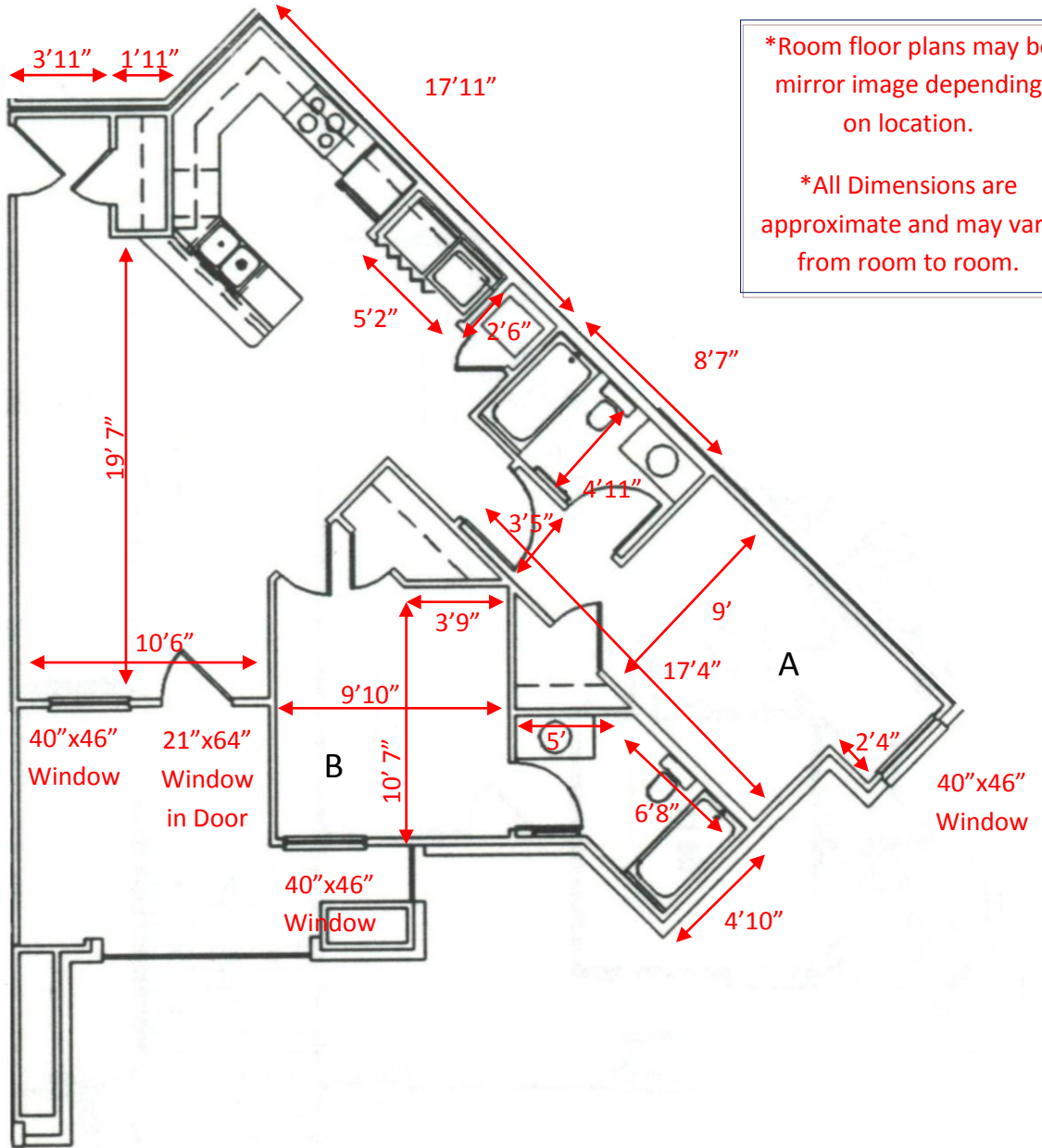

*Room floor plans may be mirror image depending on location.

*All Dimensions are approximate and may vary from room to room.

Floor Plan Type	Room Number		
Bost			
<u>North Monroe Apartments Floor Plan 1</u>	101	201	301
	102	202	302
	103	203	303
	104	204	304
	105	205	305
	106	206	306
	107	207	307
	108	208	308

Floor Plan Type	Room Number		
Davis			
<u>North Monroe Apartments Floor Plan 1</u>	101	201	301
	103	203	303
	104	204	304
	106	206	306
	107	207	307
	109	209	309
	110	210	310
	112	212	312

<u>North Monroe Apartments Floor Plan 2</u>	102	202	302
	105	205	305
	108	208	308
	111	211	311

Floor Plan Type	Room Number		
Kamm			
<u>KPF Apartments Floor Plan 1</u>	101	201	301
	102	202	302
	103	203	303
	104	204	304
	105	205	305
	106	206	306
	107	207	307
	108	208	308

Floor Plan Type	Room Number		
Morsani-Smith			
<u>North Monroe Apartments Floor Plan 1</u>	101	201	301
	102	202	302
	103	203	303
	104	204	304
	105	205	305
	107	207	307
	108	208	308
	110	210	310
	111	211	311
	112	212	312
	113	213	313
	114	214	314
	115	215	315
	117	217	317
	118	218	318
	120	220	320

<u>North Monroe Apartments Floor Plan 2</u>	106	206	306
	109	209	309
	116	216	316
	119	219	319

Floor Plan Type	Room Number		
Peterson - Friend			
<u>KPF Apartments Floor Plan 1</u>	101	201	301
	102	202	302
	103	203	303
	104	204	304
	105	205	305
	107	207	307
	108	208	308
	110	210	310
	111	211	311
	112	212	312
	113	213	313

	114	214	314
	115	215	315
	117	217	317
	118	218	318
	120	220	320

<u>KPF Apartments Floor Plan 2</u>	106	206	306
	109	209	309
	116	216	316
	119	219	319

Floor Plan Type	Room Number		
Sitlington			
<u>North Monroe Apartments Floor Plan 3</u>	101	201	301
	102	202	302
	103	203	303
	104	204	304
	105	205	305
	106	206	306
	107	207	307
	108	208	308

Floor Plan Type	Room Number		
Young			
<u>North Monroe Apartments Floor Plan 3</u>	101	201	301
	102	202	302
	103	203	303
	104	204	304
	105	205	305
	106	206	306
	107	207	307
	108	208	308